

SIMPLY**CONSERVE**[®]

TABLETOP AIR PURIFIER

Model: **AM-AP1130-WH**

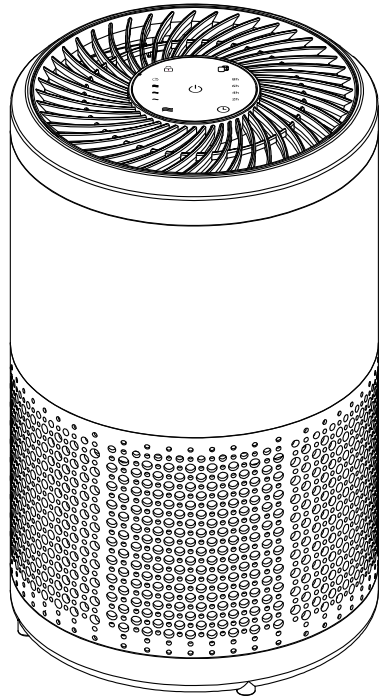

This diagram is for illustration purposes only.
Your model may vary.

Please read this manual carefully before using your air purifier.*
This product should only be used in a residence or similar location.

TABLE OF CONTENTS

Safety Precautions	3
Product Introduction	6
Control Display	7
Before Use	8
Removal and Installation of Rear Cover	8
Placement of Air Purifier.....	9
Advanced Air Filter Cartridge Installation	10
Usage	12
Turning on the Purifier	12
Manual Mode.....	12
Filtration Speed	12
Sleep Mode	13
Timer.....	13
Reset.....	13
Display Lock.....	13
Maintenance and Cleaning	14
Understanding the Role of Filters.....	15
Unique Triple Purification Technology	16
Filter Replacement	17
Advanced Air Filter Cartridge Component Refresh Instructions..	18
Troubleshooting	20
Warranty and Service.....	21
Ordering Parts or Accessories	22
Other Information	22
Recycling.....	22

SAFETY PRECAUTIONS

To avoid injury or accidents, please follow all safety precautions.

If the power cord is damaged, it must be repaired or replaced by the manufacturer.



WARNING



Do not touch the power plug with wet hands.

This may cause electric shock.



Before cleaning the air purifier, make sure the power supply has been disconnected.



Only 120V~AC power supply can be used.

The use of universal sockets or different power sources may cause overheating and fire.



Plug the air purifier into the power outlet before starting the unit.

If the plug is not fully inserted into the outlet, it may cause electric shock, overheating, or fire. Do not use damaged plugs or loose power outlets.



Do not damage the power cord or socket.

When using the air purifier, do not bind or twist the wires. Damaged wires may lead to electric shock, short-circuiting, or fire. Do not cut, refit, twist, poke, or pull wires, or place heavy objects on wires or sockets.

SAFETY PRECAUTIONS (continued)



WARNING



Clean the power plug regularly. If dust accumulates on the power plug, the insulation component could become damaged, resulting in fire. Remove the power plug and clean it with a dry cloth. Do not use a wet cloth! If the air purifier is not used for an extended period of time, the power plug should be disconnected.



Do not disassemble. Unauthorized disassembly or modification of electrical appliances may lead to electric shock, failure, or fire.



Do not place rods or other metal objects near the air outlet or inlet. They may come in contact with the internal components and cause electric shock or damage.



Do not use benzene, thinner, or other solvents to clean the air purifier. The use of hazardous solvents may damage the air purifier, causing a short circuit, resulting in electric shock or fire.



Do not use this air purifier in places with greasy airborne particles. For example, in the kitchen, the air purifier could become contaminated with grease, which would damage the product. The air purifier should not be used for ventilation or air extraction.



Do not use the air purifier in a room while also using fumigation insecticides. Chemical residues could accumulate in the unit and later be released from the air outlet, endangering occupant health. After using insecticide, the room should be thoroughly ventilated before using the air purifier.

SAFETY PRECAUTIONS (continued)



WARNING



Do not get the unit wet.
Electric shock and fire may occur.



When unplugging the unit, pull from the power plug, not the cable.
Pulling directly on the cable could damage the internal wires, leading to fire or electric shock.



Do not use this air purifier in places with high temperature, high humidity, or where it may be touched when wet, such as in the bathroom. Doing so may cause electric shock or fire.



Do not let volatile substances or combustible materials, such as tobacco or sparks, enter the unit. Fire may occur.



WARNING

In case of any of the following conditions, turn off the power to the air purifier immediately:

- A switch does not work.
- The circuit breaker trips or the fuse burns out.
- The power cord is abnormally hot.
- You smell a burning odor or hear an abnormal sound or vibration.
- You observe any other abnormal symptoms.



WARNING

If you need to move the product, first disconnect the power cord.

- Be sure to move the air purifier slowly.
- Do not move the air purifier by pulling the power cord.
- Do not move the unit while it is operating.

PRODUCT INTRODUCTION

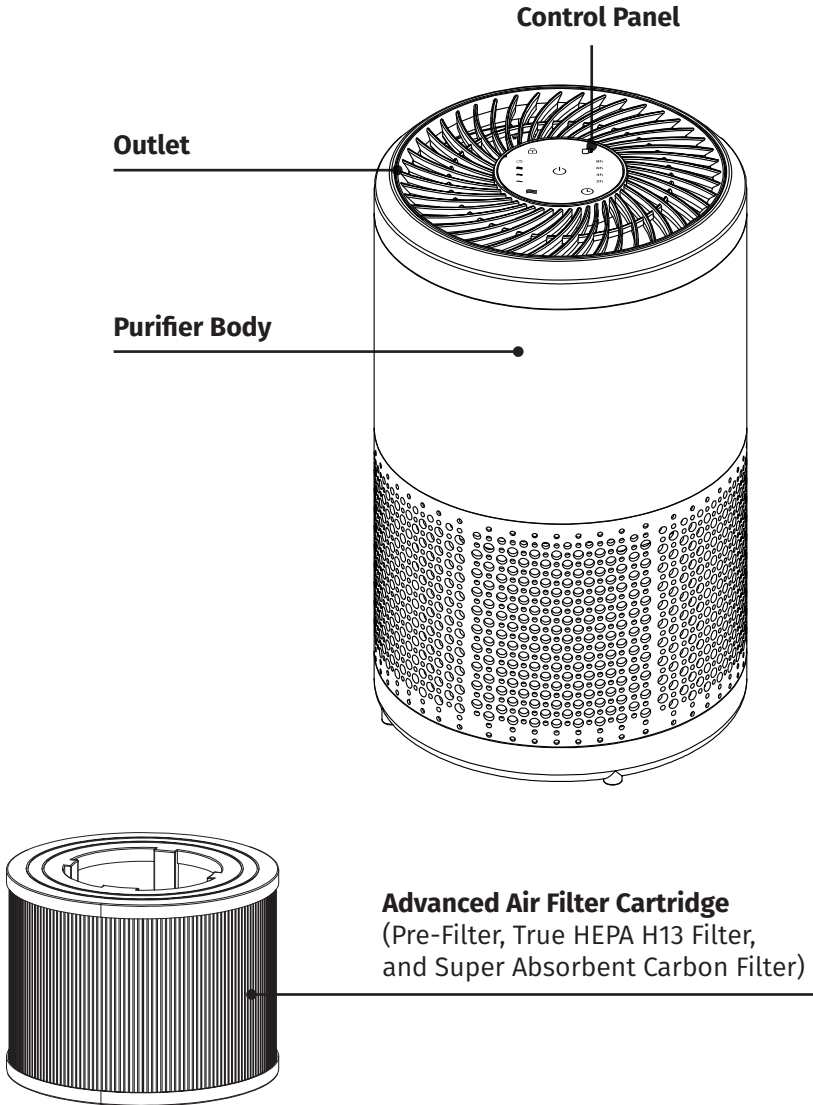

This diagram is for illustration purposes only. Your model may vary.

CONTROL DISPLAY

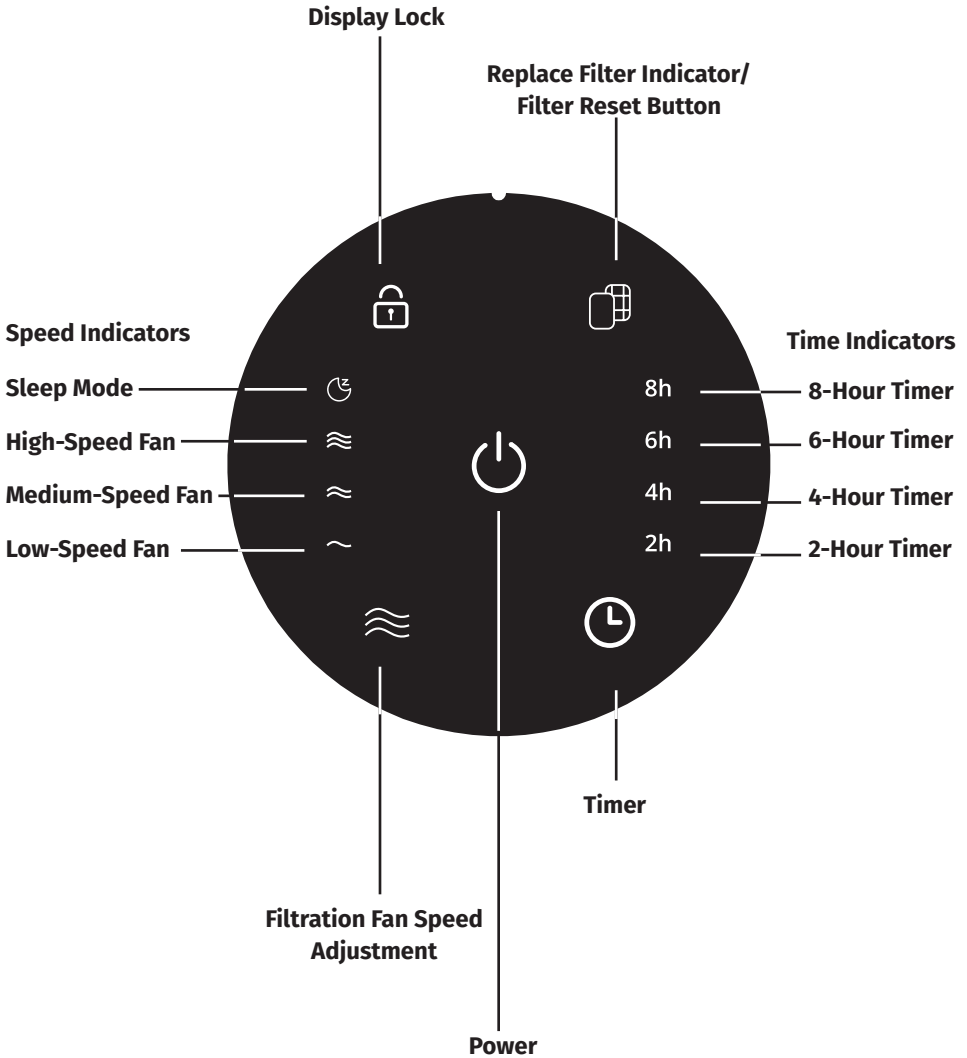

REMOVAL AND INSTALLATION OF BOTTOM COVER

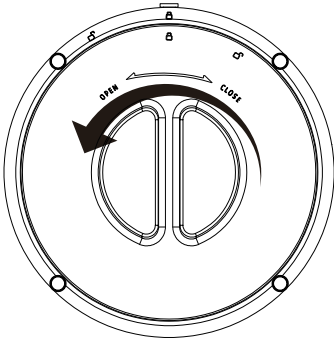

1 Remove cover

Hold unit with one hand and with the other hand, rotate bottom cover counter-clockwise to "open" position.

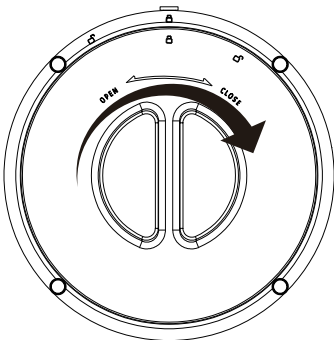
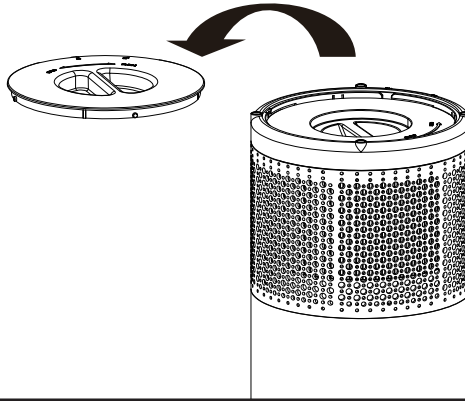

2 Re-install cover

Re-install the cover by aligning indicator triangle with unlock icon, then rotate cover clockwise until triangle on cover aligns with the lock icon on housing.

PLACEMENT OF AIR PURIFIER

To achieve purified air circulation in your room, make sure the unit's air inlet and outlet have at least 8 inches of clearance from walls and other objects. Obstructing the unit's air inlet or outlet will lower the purifier's cleaning efficiency.

Place the unit at least 3 feet away from TVs, radios, and other electronic appliances.



Do not plug the power cord into an outlet already being used by a TV, radio, or other electronic appliance.

If you use the unit in the same place for an extended period of time, the wall nearest the air purifier may become dirty.

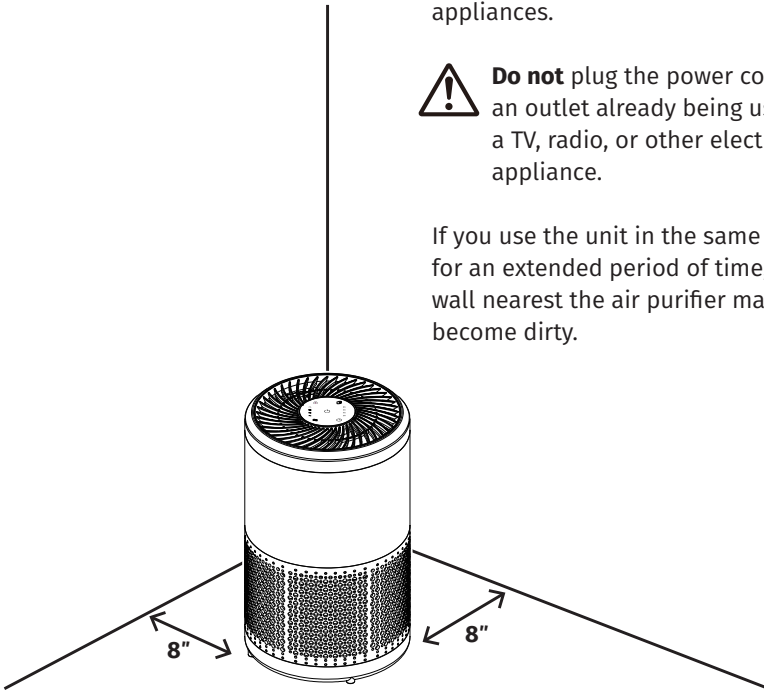

ADVANCED AIR FILTER CARTRIDGE INSTALLATION

This air purifier is equipped with an Advanced Air Filter Cartridge. Before using the product, remove the filter's outer packaging. Place the filter back in the unit after doing so.

⚡ WARNING

- Disconnect the power supply before the unit is transported or serviced.
- Do not operate the machine without its filter installed.
- Remove the filter's plastic packaging before using the machine.

OPERATION STEPS

When using the air purifier for the first time, follow the steps below to install the Advanced Cartridge correctly.

- 1** Remove all packaging materials and place the machine on a dry, stable, and level surface.

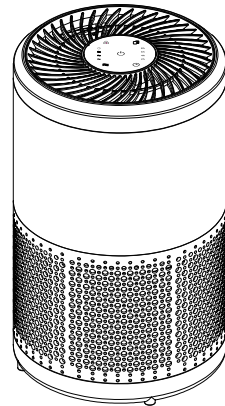
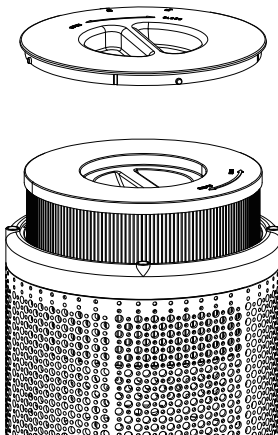

- 2** Remove the bottom cover by holding unit with one hand and with the other hand, rotate bottom cover counter-clockwise to "open" position.

OPERATION STEPS (continued)

- 3** Remove the Advanced Cartridge from inside the air purifier.

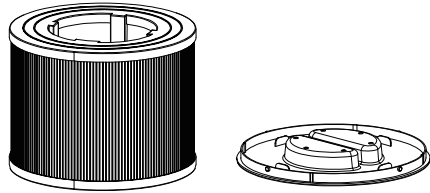

- 4** Remove the packing material from the Advanced Cartridge.

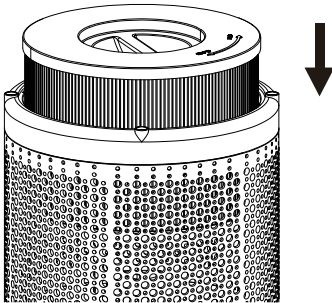

- 5** Put the Advanced Cartridge back into the air purifier.

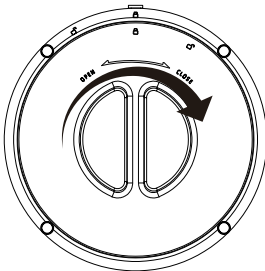

- 6** Re-install the cover by aligning the indicator triangle with the power cord, then by rotating the cover clockwise until the triangle on the cover aligns with the triangle on the housing.

TIP

When installing the bottom cover, use caution to avoid pinching your hand.

PLUGGING IN THE MACHINE

When the power is plugged in, the machine will sound, all indicator lights will flash on and then half off, and the machine will enter standby mode.

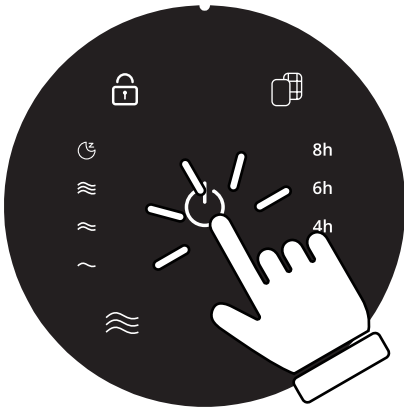

TURNING ON THE PURIFIER

The product utilizes a fan system composed of a Brushless AC motor, centrifugal fan and air ducts. To create air circulation, the unpurified air passes through the bottom of the unit, then through the HEPA cartridge filter. Purified air exits the unit through the air outlet at the top of the housing. This cycle is continuous as long as the unit is operating. A more visual representation of this process can be found on page 15.

MANUAL MODE

Once the unit has been plugged in and enters standby mode, press the power button to begin operation. The air purifier will then enter manual mode.

TIP

To turn the product off, press the power button and then unplug the machine.

FILTRATION SPEED

When the unit is running, press the filtration fan speed button until the desired speed indicator is illuminated.

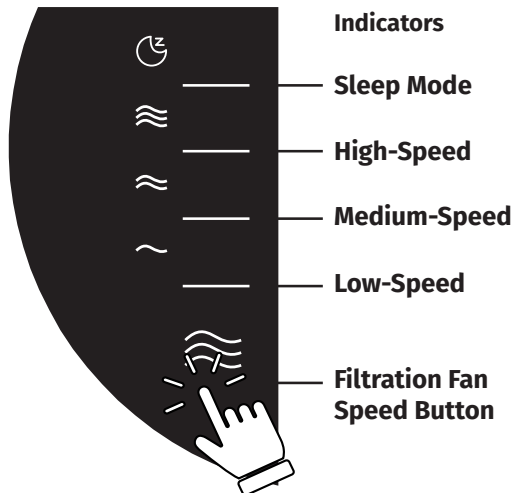

SLEEP MODE

When in sleep mode, the fan will run while all other indicators are off. Press any key to exit sleep mode.

DISPLAY LOCK

Press and hold the display lock button for approximately three seconds, until you hear a sound. The panel will then enter the display lock state. If you try pressing any other buttons, the display lock indicator will flash three times to indicate the lock is active. Other button functions will be invalid. Hold the display button lock for another three seconds to prompt the indicator noise and exit display lock.

RESET

When the filter is replaced, press the reset button for three seconds after the new filter has been installed. This resets the filter and turns off the "Replace Filter" indicator.

FILTRATION SPEED

When the unit is running, press the filtration fan speed button until the desired speed indicator is illuminated. The speed can be set for Low, Medium, High, and Sleep Mode.

TIMER

When the unit is running, press the timer button until the desired run time indicator is illuminated. The timer can be set for 2, 4, 6, and 8-hour increments.

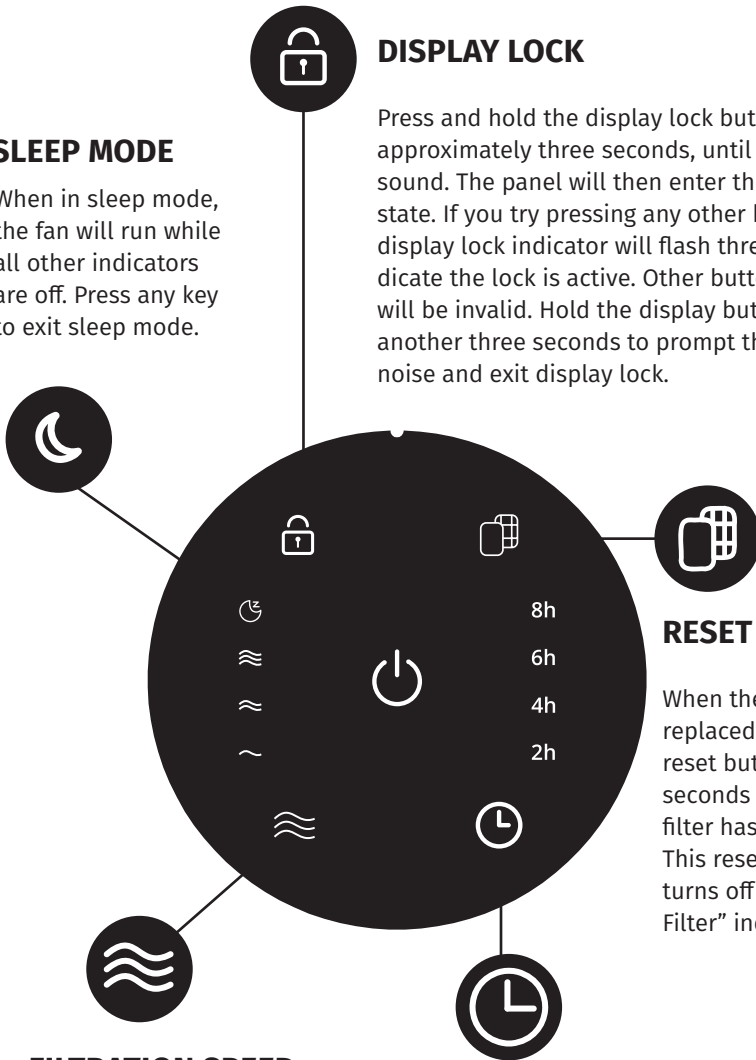

MAINTENANCE AND CLEANING

Clean the inside and outside of the purifier regularly to prevent dust accumulation. Use a soft, dry cloth to wipe dust off the purifier and purifier filter. Clean the air inlet and outlet filter with a soft, dry cloth.

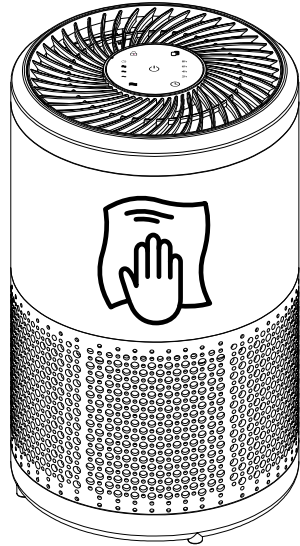
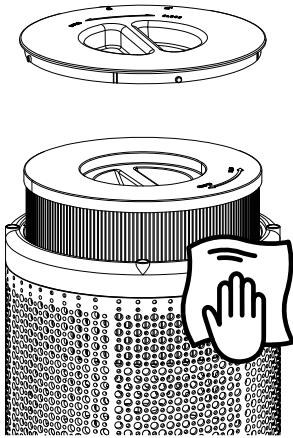

⚡ WARNING

- Unplug the power plug before cleaning the product.
- Do not immerse the product in water or any other liquid.
- Do not use abrasives, corrosives, or flammable cleaning agents such as bleach or alcohol to clean any parts of the product.
- The 3-stage air purification filter is not washable.

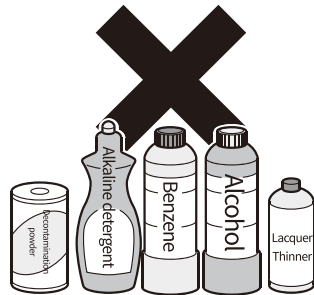

UNDERSTANDING THE ROLE OF FILTERS

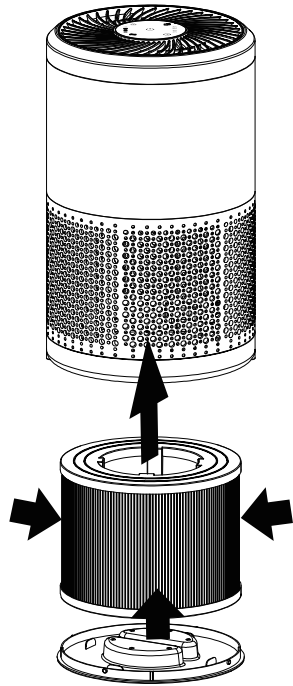
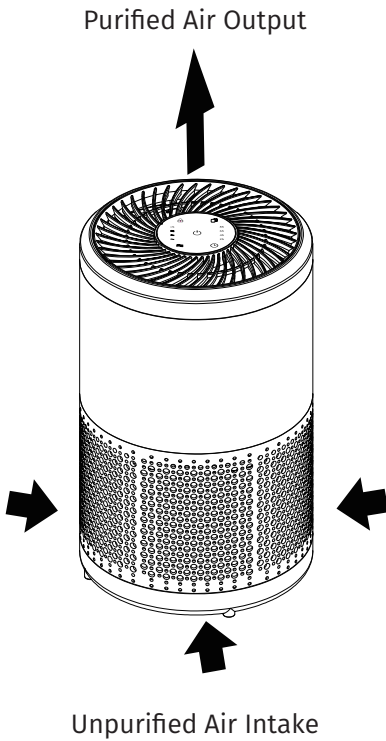

Unpurified air enters the Advanced Cartridge through its outer surface. Purified air exits from the middle of the Advanced Cartridge and travels upward.

Diagram is for illustration purposes only. Your model may vary.

UNIQUE TRIPLE PURIFICATION TECHNOLOGY

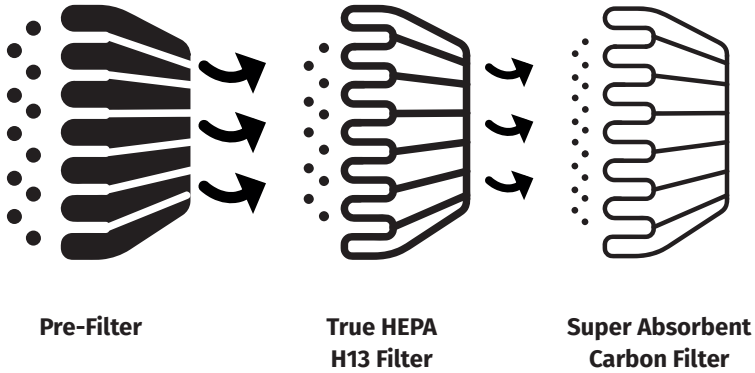

Pre-Filter

Captures large particles

True HEPA H13 Filter

True HEPA H13 filter traps fine particles and pollutants down to 0.3 microns

Super Absorbent Carbon Filter

Eliminates airborne toxins and odors

NOTE

High-efficiency HEPA and activated carbon are combined in the same composite filter.

KNOW YOUR ADVANCED CARTRIDGE COMPONENTS

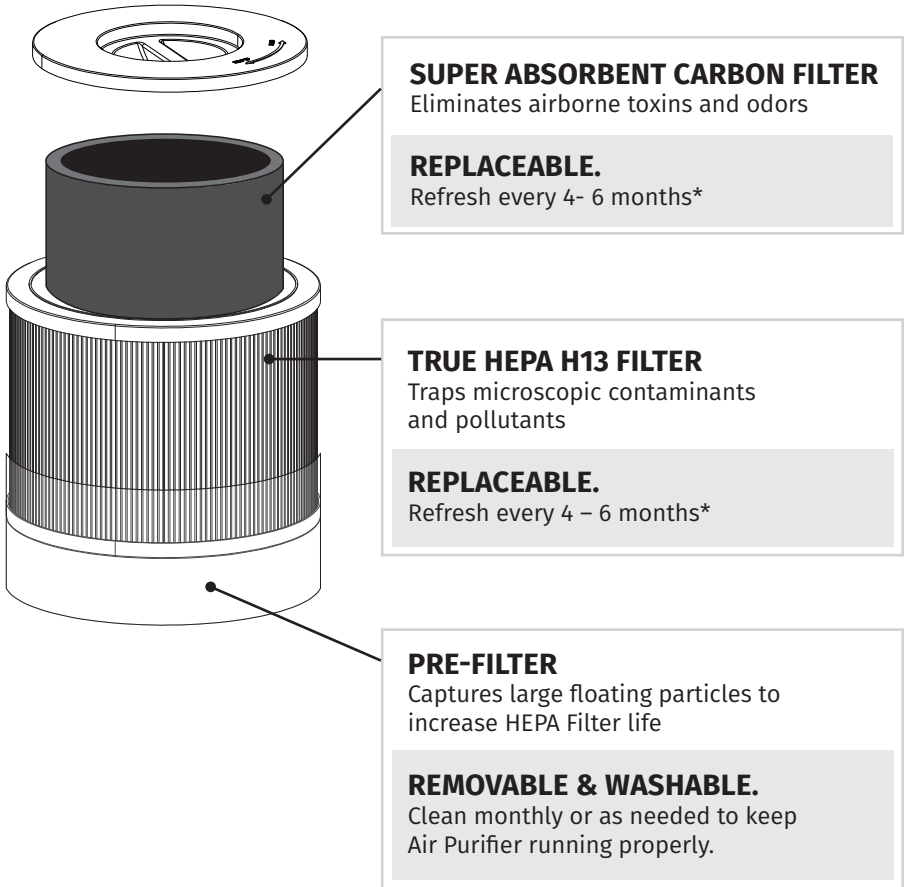

*Replacement timing may vary depending on the space where the air purifier is used. Homes with pets, exposure to smoke, and other variables will contribute to the filters being replaced more frequently.

NOTE

Did you know that your Air Purifier Advanced Air Filter Cartridge is made of affordable, replaceable and removable/washable components?

ADVANCED AIR FILTER CARTRIDGE COMPONENT REFRESH INSTRUCTIONS

- 1** Turn off the power and unplug the machine.

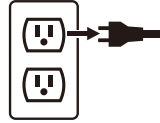

2 Removing the Advanced Air Filter Cartridge

- a. Remove the bottom cover of the Air Purifier. Hold the unit with one hand. Use your other hand to rotate the bottom cover counterclockwise to “open” position.
- b. Remove the Advanced Cartridge from the Air Purifier and place it on a flat surface, Quick-Release Lid Side Up, for disassembly.

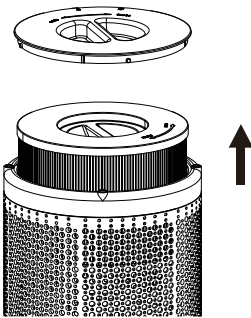

3 Removing, Washing & Re-Attaching the Pre-Filter

- a. The Pre-Filter is held together with hook and loop fastening strips. Remove the Pre-Filter from the Advanced Filter Cartridge by gently separating (pulling) the hook-side from the loop-side of the fastening strips.

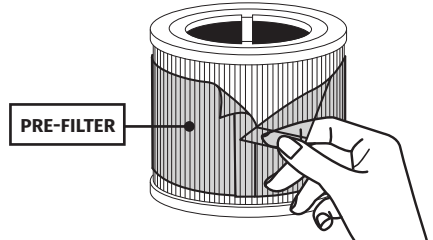

- b. **Hand-wash** the Pre-Filter with soap and water until clean.
- c. **Air-dry** the Pre-Filter completely, before re-attaching it to the Advanced Cartridge.
- d. **Re-attach** the Pre-Filter by wrapping it around the Advanced Cartridge and pressing its hook and loop fastening strips together.

⚡ ATTENTION

When the indicator light flashes, it will also make a sound to remind you to replace a component of the filter. It is recommended to replace your filter components regularly and when this indicator goes off for optimal performance.

4 Replacing the True HEPA H13 Filter and Super Absorbent Carbon Filters

The True HEPA H13 and Super Absorbent Carbon filters are sold as a composite filter and replaced at the same time. Look for the Advanced Cartridge Replacement Filters, part number AM-AP1130-FLTRPACK, when purchasing.

Used Filter Removal

- Remove and wash the Pre-Filter as indicated in Steps 3a-c. DO NOT THROW AWAY
- Remove the Lid by rotating it in the direction of the “OPEN” arrow and lifting upwards. DO NOT THROW AWAY
- Remove the composite True HEPA H13 and Carbon filter by lifting it up and off the Inner Frame of the Base. THROW AWAY. It contains trapped contaminants and cannot be recycled.

Replacement Filter Installation

- Slide the Replacement Filter (composite True HEPA H13 and Super Absorbent Carbon Filter) over the Inner Frame of the Base. Press down to seat it inside the Base. Visually inspect to verify the Replacement Filter is placed completely inside the Base. Adjust if necessary.
- Set the Lid on top of the Replacement Filter. Make certain the Replacement Filter is completely contained inside the Lid. Adjust if necessary.
- Rotate the Lid so its (4) Arrow Indicators align with the (4) Line Indicators on the Base. Once aligned, apply slight downward pressure to the Lid while rotating it in the direction of the “CLOSE” arrow until it stops. The Lid is now locked in place.
- Reattach the Pre-Filter as indicated in Step 3d.

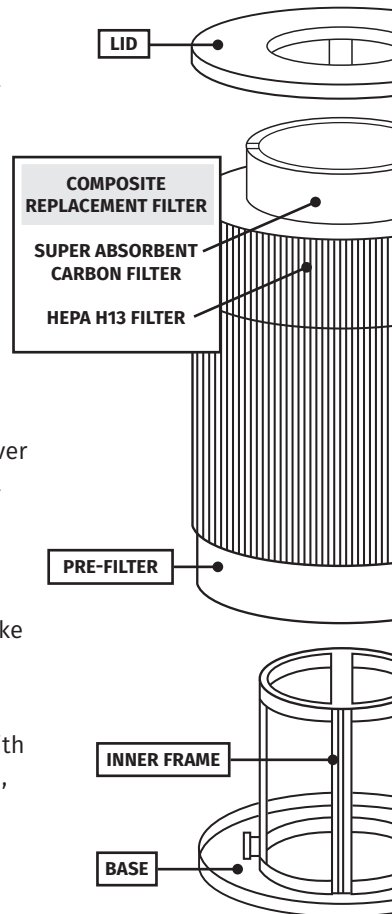

TROUBLESHOOTING

These are common situations that may be encountered when using this product. If you are unable to solve your issue using the information below, please contact our customer service center at customercare@amconservation.com.

State	Possible Causes	Solutions
The machine will not start	Power plug is not plugged in	Remove the power plug cord and plug it in again.
	Power plug or wire is damaged	Contact customer service.
Fan not working	Machine is not on	Plug in the power and turn on the machine again.
	Motor is damaged	Contact customer service.
	Motor is loose or foreign particles are inside the machine	Contact customer service.
Poor purification performance	Filter was not replaced	Install a new filter.
	Air inlet or outlet is blocked	Contact customer service.
	Filter's plastic packaging has not been removed	Remove the plastic package.
	Not enough space around the machine to allow proper ventilation	Ensure the air inlet and outlet are at least 8" away from obstacles.
	No filter in the machine	Ensure filters are placed in the machine in the order indicated.
	Room is larger than purifier's cleaning capacity	Re-check whether the area of the room is consistent with the machine's cleaning specification.

IDLE UNIT

When the unit is idle and not in use, unplug the unit and thoroughly dry the interior. Store the machine in a dry, ventilated place in a vertical position. Laying the product on its side or in an upside-down position may lead to product failure.

WARRANTY AND SERVICE

If you need information or have any questions, please contact our customer service center at customercare@amconservation.com or 843-971-1414.

AM Conservation warrants that this product is free from defects in material and workmanship for a period of 1 year from the date of the first purchase or the original distribution of the product under an energy conservation program, subject to the proper installation and/or use of the product. For full standard limited product warranty, please visit amconservation.com/warranties.

*Failure to comply with the assembly, installation, or use instructions will invalidate the applicable product warranty and may cause product malfunction, deficiency, or breakdown, which may result in an injury or property damage.

Neither AM Conservation nor product distributor, supplier, or manufacturer are responsible for any adverse outcome that customer might experience as the result of not following the provided assembly, installation, or use instructions.

ORDERING PARTS OR ACCESSORIES

To order machine parts or accessories, please contact our customer service center at customercare@amconservation.com.

OTHER INFORMATION



Recycling

When discarding electronics products, do not dispose of them with general domestic waste. Research your local regulations for disposing of electrical products. Proper disposal helps protect the environment and human health.