



Potential dangers from accidents during installation and use are divided into the following two categories. Closely observe these warnings, they are critical to your safety.

 WARNING	WARNING indicates a potentially hazardous situation which, if not avoided, could result in death or serious injury.
 CAUTION	CAUTION indicates a potentially hazardous situation which, if not avoided, may result in minor or moderate injury.

Requests to Installers

 **WARNING** In order to use this product safely, read this installation manual carefully and follow the installation instructions.

- Failures and damage caused by erroneous work or work not as instructed in this manual are not covered by the warranty.
- Refer to installation manual attached to the appliance as well.
- Check that installation was done in accordance with this Installation Manual upon completion.
- After completion of installation, be sure to hand this Installation Manual to the customer.
- When you fasten the screws on the terminals (Warning lamp terminal and so on), do not use electric drivers, impact drivers and so forth. Tightening with excessive force may cause the terminals to be damaged and lead to failures.

Contents

1. Included Accessories	2	10. Maintenance Monitors and Additional Settings	16
2. Optional Accessories	2	11. Additional Remote features.....	18
3. Introduction	3	----- [RC-7649M]-----	
4. Installing the System Controller	4	12. Remote Controller	20
5. Wiring Diagram	6	13. Remote initial setup	21
----- [RC-9018M]-----		14. Additional Remote features	24
6. Remote Controller.....	7	-----	
7. Remote initial setup	9	15. Additional System Controller Features.....	27
8. Recirculation Pump Timer Setup	13	16. System design, Gas, and Water piping.....	31
9. System Check Button.....	15	17. Follow-up Service	35

Note: If the system controller (SC-401-6M) is installed in conjunction with the NC380-SV-ASME (with remote controller RC-7649M), the initial settings (refer to page 21) must be followed. Failure to change the initial settings may result in an error code “730” appearing on the remote controller.



Read page 36 for procedure to replace System Controller

If at any time during the installation and setup of this product you have questions or concerns, contact Noritz America at 866-766-7489 or visit <http://support.noritz.com/>.



1. Included Accessories

Check for any missing items before starting installation.

Part	Shape	Qty	Part	Shape	Qty
Tapping Screw (4 x 8)		3	*1 Vinyl Tie		3

*1 : Use the included vinyl tie to bind any excess length of wire

2. Optional Accessories

Name	Usage	Qty
*2 Remote controller RC-9018M	*2 Always necessary except using NC380-SV-ASME.	1
Remote controller Cord RC-CORD10 RC-CORD26	-The communication cord between the system controller and the remote controller can be lengthened up to a maximum total length of 450 feet. -The communication cord between the system controller and each water heater can be lengthened up to a maximum total length of 45 feet.	Total number of units in system - 1
NWC-ADAPTER (NAW-1 US)	For remote monitoring the multi-unit system through the Mobile App.	1

*2 : RC-7649M only may be used when using NC380-SV-ASME.

CAUTION : Be sure to use the remote controller cord as listed above. If a different cord is used, the equipment may fail or not operate properly.

● When two or more multi-unit systems are installed in parallel

One remote controller is necessary for each multi-unit system (i.e. 3 multi-unit systems will require 3 system controllers and 3 remote controllers). Each system will have separately wired remote controller cords.

■ For the combined use pattern

A. When there is no circulation pipe (standard type)

Number of units	System controller	Remote controller
1 to 6	SC-401-6M	*2 RC-9018M

*2 : RC-7649M only may be used when using NC380-SV-ASME.

B. When there is a circulation pipe

Condition	Number of units	System controller	Remote controller
Recirculation type (circulation heat-retention with external pump)	1 to 6	SC-401-6M	*2 RC-9018M
Storage Tank Recirculation type (circulation heat-retention with external pump)	1 to 6	SC-401-6M	*2 RC-9018M

*2 : RC-7649M only may be used when using NC380-SV-ASME.

3. Introduction (see list of points below)

Introduction to the "SC-401-6M" System Controller

Overview

This manual is intended to provide instruction for the installation, operation, and features of the SC-401-6M system controller. It is divided into 4 main sections:

1. Installation of the SC-401-6M system controller
2. Initial programming of the Remote controller
3. Additional features of the Remote controller and the SC-401-6M system controller
4. Plumbing diagrams and general information about water and gas piping

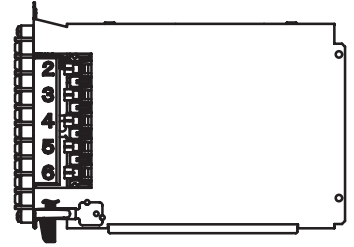

Read this manual carefully and follow the instructions as written. If you have any questions, contact Noritz America at 866-766-7489 or visit <http://support.noritz.com/>.

Basic Operation

The SC-401-6M system controller is used to combine 1 to 6 Noritz heaters into a single "multi-unit system" The system controller stages units on and off based on hot water demand and rotates their operation to ensure even usage. It also has two additional modes which optimize the system for operation with a recirculation line or storage tank.

(Note: for systems of 7-12 units use the SCU-401-12M system controller
for systems of 13-24 units use the SCU-401-24M system controller)

Unit Staging

Staging allows the multi-unit system to track hot water demand from the minimum flow rate of a single unit up to the maximum output of several units. When the primary firing heater reaches ~50% of its maximum output, the system controller activates the next unit in the system. When both these units reach ~50% of their maximum output, a third unit is activated and so on. The SC-401-6M may also be configured to activate two heaters during primary firing to allow for rapid initial hot water demand.

UNIT1	UNIT2	UNIT3	UNIT4	UNIT5	UNIT6
1st	2nd	3rd	4th	5th	6th
↓ Rotation					
6th	1st	2nd	3rd	4th	5th
↓ Rotation					
5th	6th	1st	2nd	3rd	4th
↓ Rotation					
4th	5th	6th	1st	2nd	3rd

System Selection

The SC-401-6M allows the user to select two additional system types: "Recirc" and "Tank recirc." These settings optimize performance with recirculation and storage tank systems, and allow the system controller to operate one or two pumps.

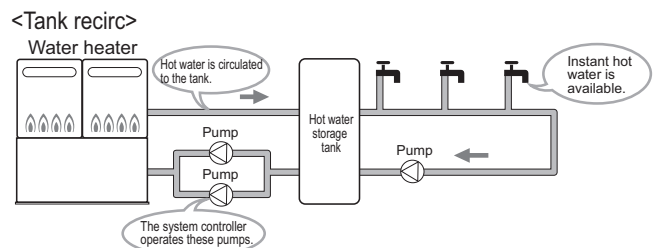
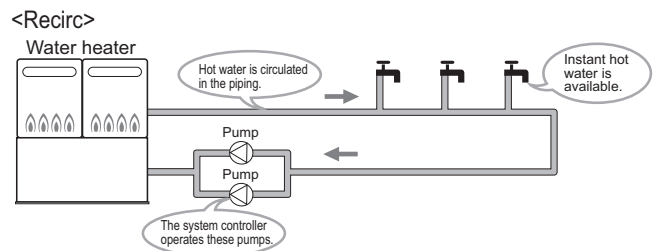

* These diagrams are for illustration purposes only.

4. Installing the System Controller (Electrical Wiring)

Consult a qualified electrician for the electrical work.

CAUTION

- Do not connect electrical power to all water heaters (do not turn ON the power supply) before all electric wiring is completed. Otherwise, electric shock or failure of the water heater and system controller may occur.
- If a remote controller cord is not connected, there is a case that unexpected temperature flows out. So check it is surely connected.
- Be sure to tighten the screw to the terminal block manually and do not use an electric screwdriver or impact driver. Otherwise, the terminal block may be damaged.

This appliance must be electrically grounded in accordance with local codes, or in the absence of local codes, with the National Electrical Code, ANSI/NFPA 70. In Canada, the latest CSA C22.1 Electrical Code.

Caution: Label all wires prior to disconnection when servicing controls. Wiring errors can cause improper and dangerous operation.
Verify proper operation after servicing.
Field wiring to be performed at time of appliance installation.

Open the cover of the external remote controller cord terminal block of each water heater.

● Installation for unit 1 (Water heater to which system controller is installed)	* Circuit board is indicated as P.C.B.
Operation	Illustration
<p>Open the front cover of the water heater</p> <p>1. Connect the remote controller cord to the remote controller cord terminal block. * Refer to the remote controller section in the installation manual of the water heater.</p> <p>2. Connect the opposite side of the remote controller cord that was connected in the step 1 to the remote controller. * Refer to the installation manual of the water heater.</p> <p>3. Slide the system controller into the bracket in the back of the case. Use the two included tapping screws to attach the system controller to the inside of the heater and to connect the ground wire.</p>	
<p>4. 1) Connect the connector B5 (white: nothing is connected when the product is shipped from factory) with a tag "SYSTEM CONTROLLER" that comes from the P.C.B. of the water heater to the connector B5 (white) with a red tag "to Connector B5" that comes from the system controller.</p> <p>2) Disconnect the connector (white) from the remote controller cord terminal block of the water heater and the connector 90 (white) connected to the P.C.B.</p>	<p>Terminal block* for remote controller cord * The terminal block is depending on each water heater. Refer to the water heater's installation manual for detail information.</p>
<p>3) Connect the connector 90 (white: disconnected in the step 2)) that comes from the remote controller cord terminal block of the water heater to the connector 90 (yellow) with a tag "to Remote Controller Terminal" that comes from the system controller.</p> <p>4) Connect the connector 90 (white: disconnected in the step 2)) that comes from the P.C.B. of the water heater to the connector 90 (yellow) with a tag "to Connector 90" that comes from the system controller.</p>	<p>Terminal block* for remote controller cord * The terminal block is depending on each water heater. Refer to the water heater's installation manual for detail information.</p>

● Installation for each water heater of unit 1 (Unit 2 to 6: water heater to which the system controller is not attached)

Operation	Illustration
<p>5. Using the remote controller cord from each water heater, plug the connector into the system controller plugs for units 2-6. (The number of the remote controller cords necessary is determined by the total number of heaters minus one.)</p> <p>1) Connect the connector for the communication cord with unit 2 of the system controller with the connector side of the remote controller cord. The connector No.2 is for unit 2 and the connector No. 3 is for unit 3.</p> <p>* When the system controller is installed, take care not to damage the electric component in the water heater and bond the slack electric component with the included vinyl tie so that it floats on the bottom surface.</p>	<p>The illustration shows a terminal block with six connectors labeled No. 2 through No. 6. A 'water heater connection terminal / system controller plug' is shown with a 'Remote controller cord (Required accessory)' connected to it. A circular inset shows the correct connection (marked with an 'O') and an incorrect connection (marked with an 'X'). Below, a P.C.B. is shown with terminals B5, B5, 90, and 90. Wires connect these terminals to a remote controller cord. Labels indicate connections 'To unit 2', 'To unit 3', and 'To remote controller'. A legend at the bottom shows the 'Connector side' for 'For unit 1 (system controller)' and the 'Y terminal side' for 'To each water heater (unit 2 to 6)'. The remote controller cord is labeled '<Remote controller cord>'.</p>

● Installation of each water heater (Unit 2 to 6: water heater to which system controller is not installed)

<p>6. Connect Y terminal side of the remote controller cord that was connected in the step 5 to the corresponding remote controller cord terminal block of unit 2 to 6.</p>	<p>Do not have to open the front covers of the unit with external remote cord terminal block*.</p> <p>The diagram shows two water heaters, Unit 2 and Unit 6, with their P.C.B. (Printed Circuit Board) visible. Wires from the remote controller cord are connected to the Y terminal side of the P.C.B. A label 'For system controller' points to the wires entering from the left. A note states: '*It may differ depending on the water heater. Refer to the remote controller section in the installation manual of the water heater.'</p>
---	---

After all cords are connected, replace the front cover of unit #1 and the other units or the covers of the external remote controller cord terminal blocks of all water heaters.

(*Make sure to replace the front cover without crushing any wires.)

5. Wiring Diagram

◆ When six units are installed

* Connect these to the remote control terminal block in each unit

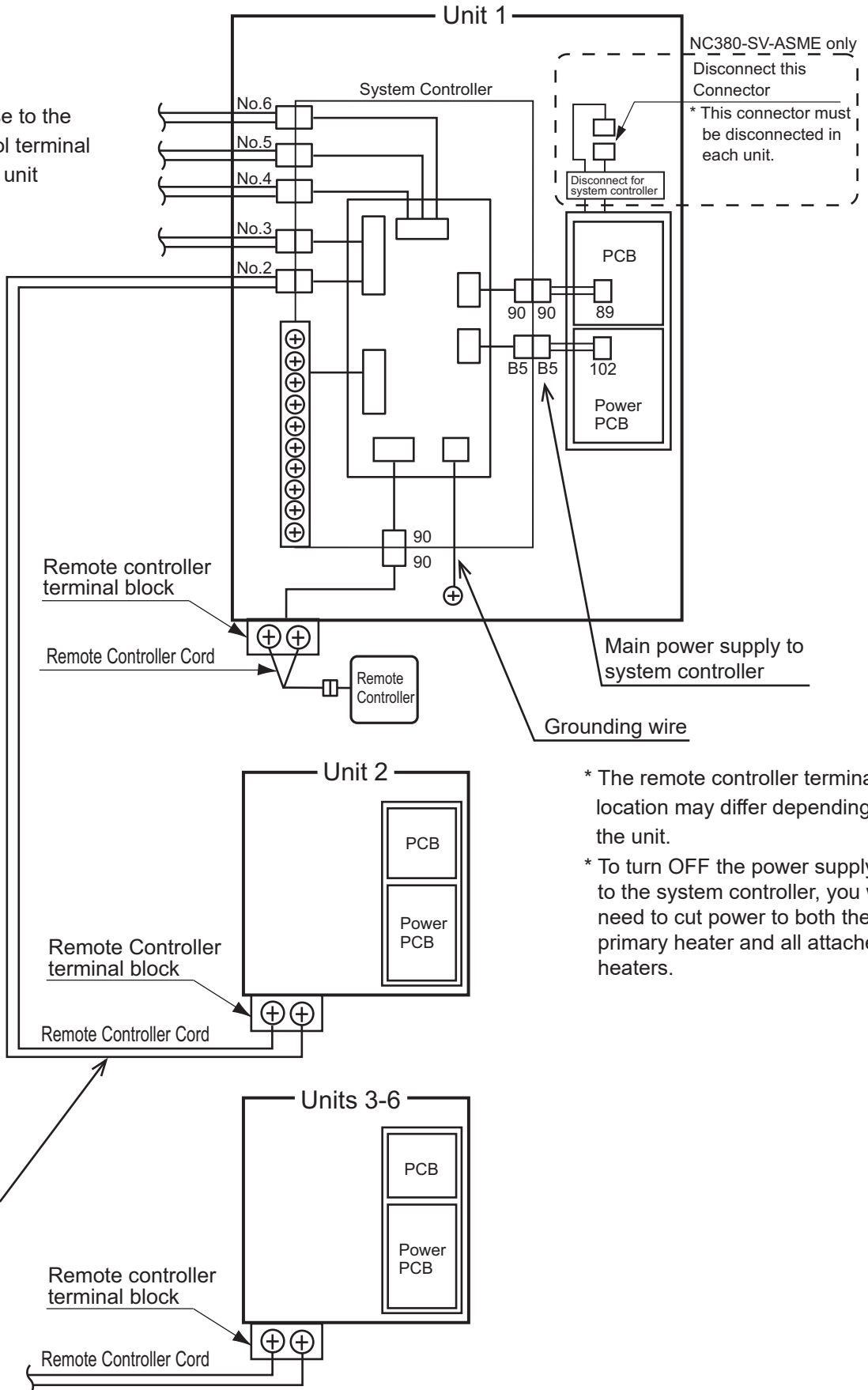

* The remote controller terminal location may differ depending on the unit.
 * To turn OFF the power supply to the system controller, you will need to cut power to both the primary heater and all attached heaters.

6. Remote Controller

■ Remote Controller (Required Accessory : RC-9018M) *Using NC380 models, refer to RC-7649M section (page 20).

◆ The remote controller will emit a tone when a button is pressed.

* This Remote Controller is not resistant to water, steam, chemicals, or UV rays. Install it in a location where it will not be exposed to these conditions. If it must be installed outdoors, use a weatherproof enclosure. Refer to the RC-9018M Installation Manual for details.

Prog Button / Indicator (Red)

Activates the automatic water heater power "ON" or "OFF" setting as determined by the user selected schedule.

Power ON /OFF Button / Indicator (Green)

For turning the water heater on/off.

Alarm Off Button / Indicator (Red)

Stops the tone that is emitted when an error occurs. (page 28.)

Speaker

Display Screen

(Next page)

Menu Button

* Use to change system settings or to return to the home screen.
* If you press the menu button and press the temperature setting buttons, **Sys monitor** is sometimes displayed. However, do not use this mode as it is meant for installation or service personnel only.

Status Button

Check the status of the system or the number of installed units. (page 15, 28.)

Remote Controller Part Number

The part number is printed on the surface of the cover.

Cover shown in the open position.

Lock Button

Locks remote controller operation. (page 19.)

Back Button

Returns to the previous screen while making system settings or checking status.

Enter Button

Confirms changes made by the user.

Hot Water Temperature Setting Buttons

For setting the hot water temperature, and other settings.

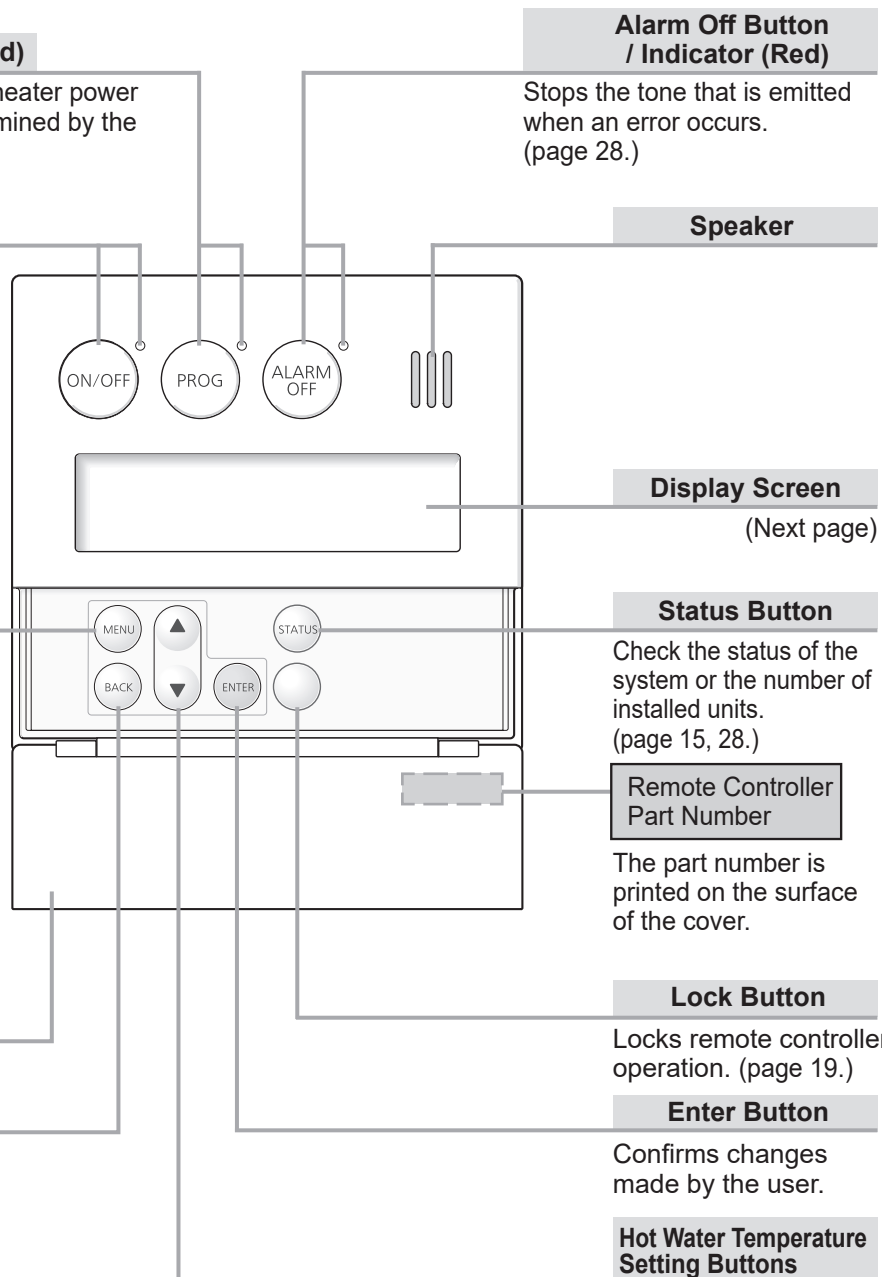

◆ Screen Display

- * The screen display shown below is for illustration purposes only. The actual display will vary depending on how the water heater is being used.
- * After a button is pressed, the display will gradually become darker to prevent unnecessary power consumption by the remote controller.

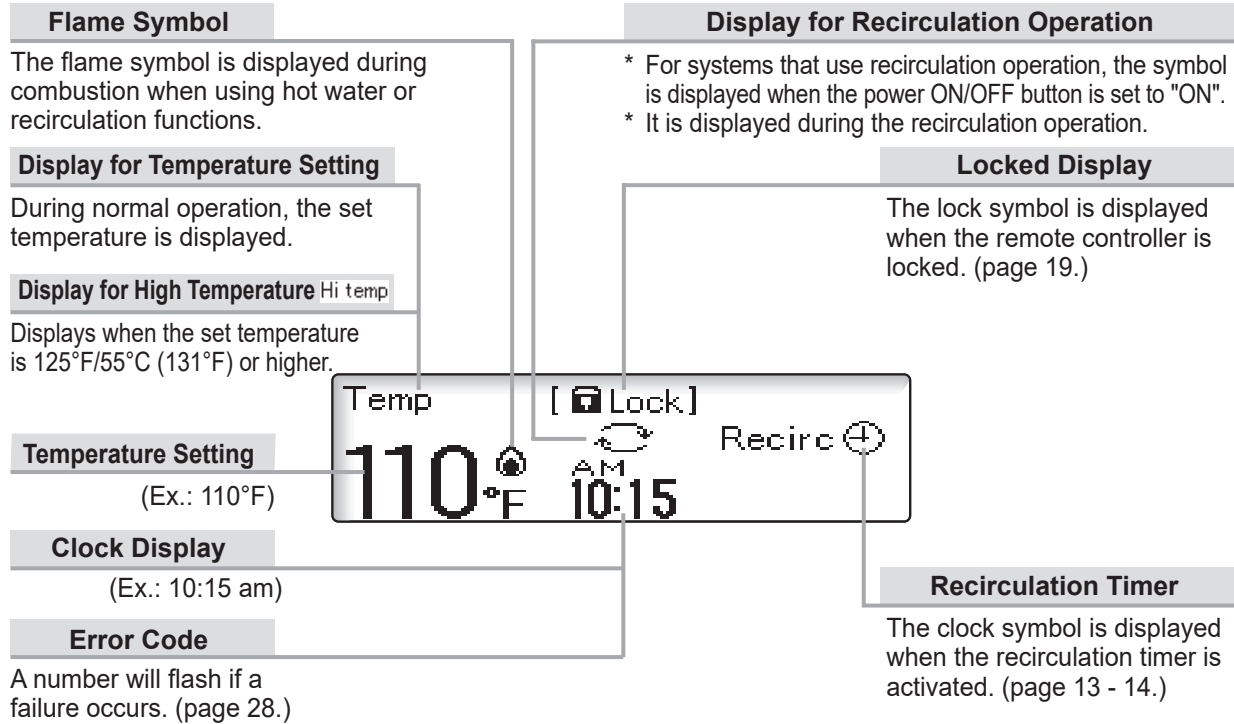

Note: As shipped from the factory, the remote controller is set to display in °F and gallons.
To adjust the display to °C and liters, refer to the page 12.

● What is the home screen? ●

The home screen is displayed when the  button is "ON".
Normally, the hot water temperature and the clock, etc. are displayed.

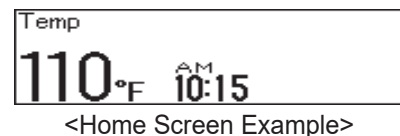

7. Remote initial setup

Initial Setting Procedure in the “System Settings” Screen



Note: When power is first connected to the multi-unit system (system controller and units), the remote enters an initial setting mode. The following instructions explain how to perform an initial setting. If you need to change these settings at a future date, follow the instructions titled System Selection and Settings in the “Initial Settings” Screen (page 10 - 12).

Operation	Screen Display	Description
Preparation Connect power to all heaters in the multi-unit system.		
1 Press the button on the remote.		
2 1) You will be prompted to choose a system type. 2) Use the buttons to navigate to the correct system type. (Standard, Recirc., or Tank Recirc.) 3) Press the button to select your system type.	 	
3 1) If you chose the “Recirc.” or “Tank Recirc.” systems, you will be prompted to turn pump rotation on or off (this setting is set to “off” by default). 2) Use the buttons to select yes (on) or no (off). 3) Press the button to set the pump rotation.		* Note: only when you connect one/two pumps to the system controller, you need to select “Yes” or “No”.
4 1) You will now be prompted to “complete system setting.” 2) Press the button to complete the system setting. 3) Once you choose “Complete system settings?”, the remote will display “System settings completed”.	 	* Note: if you chose standard system in step 2 - 2), you will immediately go to this prompt. * You may use the button to return to the previous menu at any time.

System Selection and Settings in the “Initial Settings” Screen

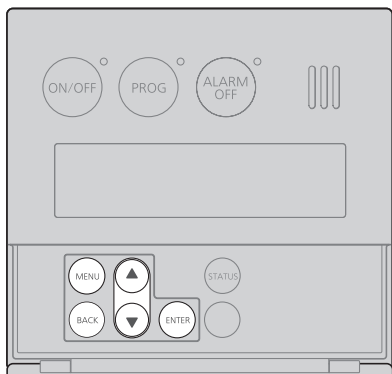

Note: Use this procedure if you need to change the system type or settings after running the “initial setting procedure”

List of the Initial settings

System type	The system type can be changed.
Sys settings	The system settings can be changed.
[°F/gal]↔[°C/L]	The unit of temperature and flow rate on the screen can be changed.
Adjust clock	The gap of time per month on the clock can be adjusted.
Save backlight	The power saving setting of the backlight on the screen can be changed.

Operation	Screen Display	Description
-----------	----------------	-------------

Access Initial Settings Menu.

- Preparation**
- 1) Turn Remote off.
 - 2) Disconnect Power to all heaters in multi-unit system.
 - 3) Wait 10 seconds or more.
 - 4) Reconnect power, DO NOT turn remote on.

- 1** Press the button.

- 2** Use the buttons “▼” to navigate to “Initial settings”.

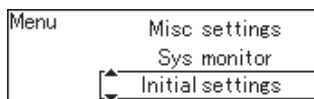

- 3** Press the button to access the initial settings menu.

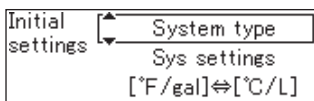

* You may use the button to return to the previous menu at any time.

Change System Type

- 1** In the initial settings menu select “System type”.

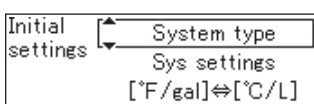



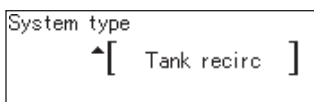

- 2** The menu will have three options: Standard, Recirc., and Tank Recirc.



- 3**
- 1) Use the buttons to navigate to the appropriate system.
 - 2) Press the button to select the desired system.

- 4** Once a system is selected, the remote will display “Set Complete”.

* You may use the button to return to the previous menu at any time.

Operation	Screen Display	Description
Change System Settings.		
1 In the initial settings menu select "Sys settings".	Initial settings System type Sys settings [*F/gal]⇌[*C/L]	
2 1) The "Sys settings" menu will display several options for the selected system type. 2) Press the  button to select the system setting you would like to alter.	Sys setting Quick staging Pump error check Pump rotation	
3 1) Use the  buttons to turn the feature on ("yes") or off ("no"). 2) Press the  button to select "yes" or "no". 3) The display will say "Set complete" once an option is chosen.	Quick staging ^ [No] Quick staging v [Yes]	* You may use the  button to return to the previous menu at any time.

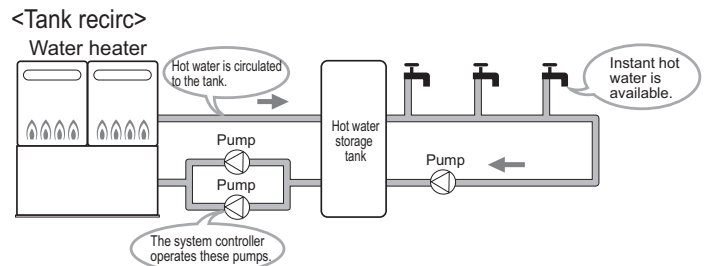
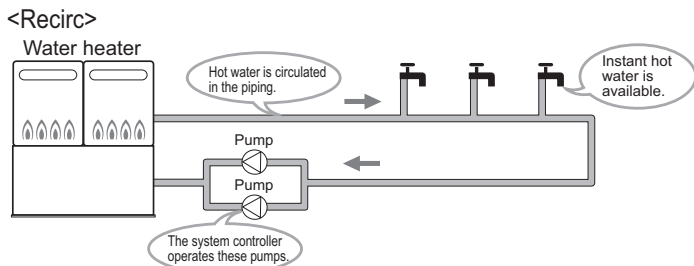
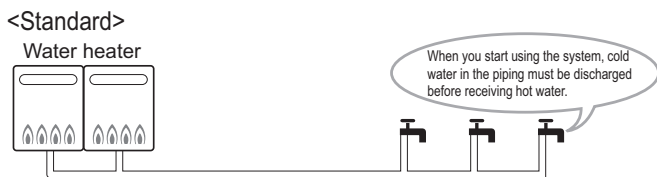





* These diagrams are for illustration purposes only.

List of the Sys settings

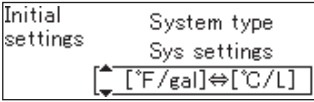
Item in the Sys settings	system type			Yes	No
	Standard	Recirc	Tank recirc		
Quick staging	Available	Available	Not Available	Units will stage more rapidly from heater to heater*	Units will stage more slowly
Pump error check	Not Available	Available	Available	System will check for flow when system controller pump terminals are energized. If no flow is present, it will display 63 error code	System will not check for pump operation*
Pump rotation	Not Available	Available	Available	System will rotate pump 1 and 2 operations	Pump 1 and 2 will operate simultaneously*

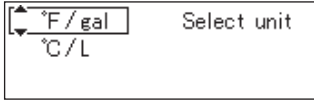
*Factory Default Settings

Operation	Screen Display	Description
Change the way the units of temperature and flow rate are displayed on the screen (standard vs. metric).		
<p>1</p> <p>1) In the initial settings menu select “[°F / gal] ⇌ [°C / L]”.</p> <p>2) Press the  button.</p>		
<p>2</p> <p>1) Use the  buttons to select the unit “[°F / gal]” or “[°C / L]”.</p> <p>2) Press the  button to set the units to be displayed.</p> <p>3) The display will say “Set complete” once an option is chosen.</p>		<p>* You may use the  button to return to the previous menu at any time.</p>
After finishing the Initial Settings.		
<p>1</p> <p>1) Disconnect Power to all heaters in the multi-unit system.</p> <p>2) Wait 10 seconds or more.</p> <p>3) Reconnect power.</p>		

8. Recirculation Pump Timer Setup

*This functionality is only available if you have selected "Recirc" as your system type in the "Initial Setting Procedure" and "System Selection and Settings" on page 9 to 10.

■ For System [Rrcrc] Setting the Recirculation System Operation Timer

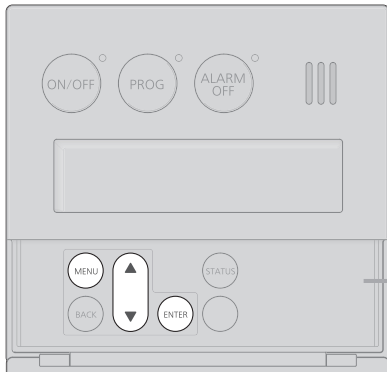

Cover shown in the open position.



* With the recirculation operation timer set, hot water will be automatically circulated in the hot water pipes. Even with this function activated, it may take several minutes for hot water to be completely circulated through the plumbing system. Set the timer to activate the recirculation system prior to the first use of hot water to ensure hot water is instantly available.

* Multiple recirculation time periods can be set.

* Until the timer is deactivated (Next Page), the recirculation system will operate daily at the set times.

* When the recirculation system is turned "OFF" by the timer, the water heater will still remain "ON" and can be used normally.

Operation	Screen Display	Description
-----------	----------------	-------------

This example describes setting the recirculation system to operate between 5:00 am - 8:00 am.

Preparation Check that the current time is properly set.
(Setting the time page 18.)

- 1**
- 1) Press the **MENU** button inside the cover, Select "Recirc menu" using the **▲** buttons.
 - 2) Press the **ENTER** button.

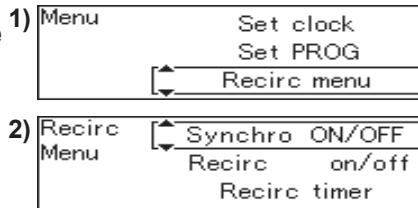

* You can set the timer regardless if the **ON/OFF** button is "ON" or "OFF".

- 2**
- 1) Select "Recirc timer" using the **▲** buttons.
 - 2) Press the **ENTER** button.

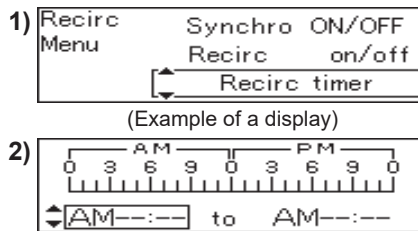

* The previous setting is displayed.

- 3**
- 1) Select "AM5:00" using the **▲** buttons.
 - 2) Press the **ENTER** button to complete the "Start" time setting.

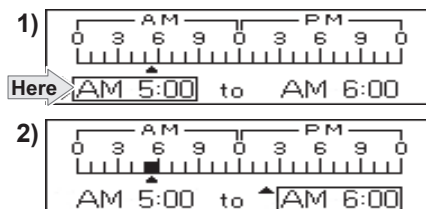













* Every time when you press the button, the time changes by one hour.

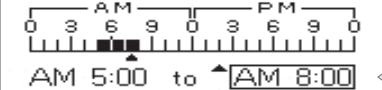
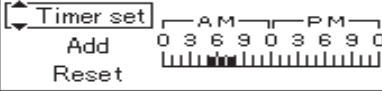

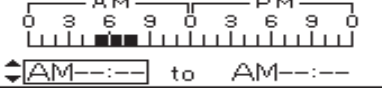
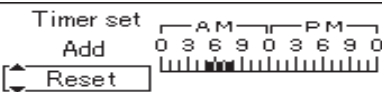
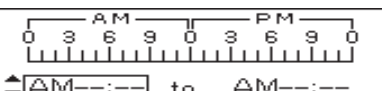
[To keep the current "Start" time]
Press the **ENTER** button without changing the "Start" time, and proceed to step 4.

[To add additional time periods to the current setting, or to cancel the previous setting]

- 1) Press the **ENTER** button without setting "Start" time.
- 2) Press the **ENTER** button without setting "End" time.
- 3) Follow the procedures "Adding Additional Time Periods" or "Resetting All Time Periods" (Next Page).

Operation	Screen Display	Description
<p>4</p> <p>1) Select "AM8:00" using the  buttons.</p> <p>2) Press the  button to complete the "End" time setting.</p> <p><Adding Additional Time Periods></p> <p>1) Select "Add" using the  buttons.</p> <p>2) Press the  button.</p> <p>3) Select the time period following the procedures in Steps 3 to 4.</p> <p><Resetting All Time Periods></p> <p>1) Select "Reset" using the  buttons.</p> <p>2) Press the  button. (All settings are cleared.)</p> <p>3) Adjust the time period following the procedures in Steps 3 to 4.</p>	<p>1)  Here</p> <p>2) </p> <p>1) </p> <p>2) </p> <p>1) </p> <p>2) </p>	<p>* Every time when you press the button, the time changes by one hour. [To keep the current "End" time] Press the  button without changing the "End" time, and proceed to step 5.</p> <p>* You can set multiple operation time periods.</p>
<p>5</p> <p>Press the  button to complete the time settings.</p>	<p>Set complete</p> <p>▼</p> <p>"Recirc timer" and "Recirc timer on" are alternately displayed on the menu (approximately 10 seconds)</p> <p>▼</p> <p></p> <p>(Example of home screen when the power ON/OFF button is turned "ON")</p>	<p>* The timer will not activate without pressing the  button.</p> <p>* If the time is not set, the time setting screen is displayed.</p> <p>* Until the timer is deactivated, the recirculation system will operate daily at the set "Start" and "End" times.</p>

● To Cancel the Recirculation System Operation Timer

- 1) Carry out steps 1 to 2.
- 2) Select "Cancelled" using the  buttons.
- 3) Press the  button.

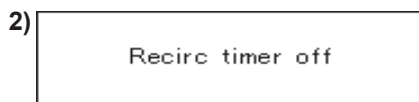
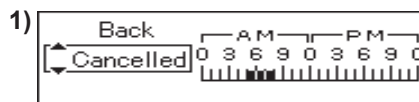

The screen returns to the Recirc Menu.

* If the  button is "ON", the screen returns to the home screen in approximately 10 seconds.

9. System Check Button



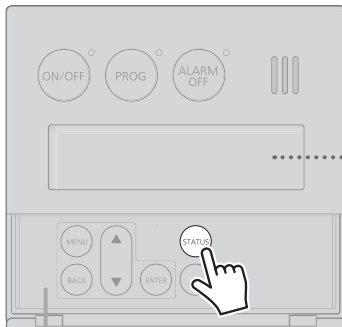

If you press the  button, you can check the status of the system



Cover shown in the open position.

```
(System [ Rrcrc ] Active [ 06 ]
Units [ 06 ] Pump1 [ OFF ]
Online [ 06 ] Pump2 [ ON ]
```

(Display Screen Example [System [Rrcrc]])

System Displayed on the Remote Controller	System Description
System [Std]	Water heater only operation.
System [Rrcrc]	<ul style="list-style-type: none"> * Water heater and recirculation operation. * During recirculation operation, hot water is always circulated in the piping to provide instant hot water when a fixture is opened. [If you set the  button to "ON",  is displayed.]
System [Tank]	<ul style="list-style-type: none"> * Water heater combined with a storage tank operation. * If a recirculation system is also installed, hot water is always circulated in the piping to provide instant hot water when a fixture is opened. [If you set the  button to "ON",  is displayed.]

10. Maintenance Monitors and Additional Settings

* It is necessary to check the flow rate for Recirculation system, and Storage Tank Recirculation system (for adjusting the recirculation flow rate).

- (1) Press Menu Button and press the ▼ Button several times to select "Sys monitor", and then press Enter Button.
- (2) Press the ▼ Button once to select "Yes", and then press Enter Button for five seconds or more.

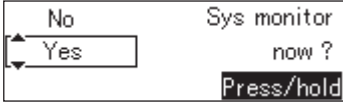

- (3) Sys monitor is displayed. Since item 03 is displayed first, you must press the ▲/▼ Buttons several times until item 14 is displayed.

- (4) Flow rate screen is displayed.

* The unit of flow rate on the screen can be changed (refer to page 12.)

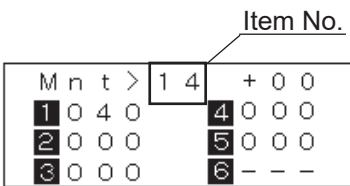

<Example of display (°F/gal)>
 Flow rate of unit 1 is 4.0 gal/min
 Flow rate of unit 2 to 5 is 0 gal/min
 unit 6 is not connected

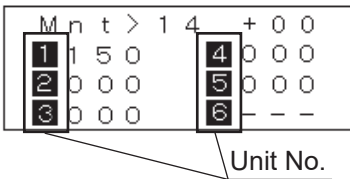

<Example of display (°C/L)>
 Flow rate of unit 1 is 15.0 L/min
 Flow rate of unit 2 to 5 is 0 L/min
 unit 6 is not connected

- (5) Press Back Button.
- (6) The screen that asks whether continue or cancel the Sys monitor is displayed. Select "cancel" by pressing the ▼ Button to terminate the Sys monitor.



<Remote controller (RC-9018M)>

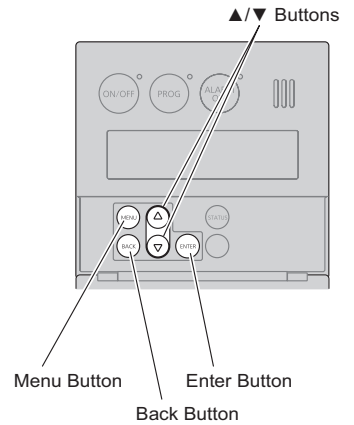

■ Additional settings of system controller

Following setting can be changed in addition to the system settings.
When determining whether or not to change a particular setting, consult with the customer first.

- Item No. 19

When multiple units are connected to the system controller, two units fire upon startup as the factory default.

However, this setting can be changed so that only one unit fires upon startup.

- Item No. 1A

By factory default, the remote controller alarm will sound when a failure of the system controller or any water heater in the system has occurred.

However, this setting can be changed so that the alarm sounds only when the entire system is down.

<Remote controller (RC-9018M)>

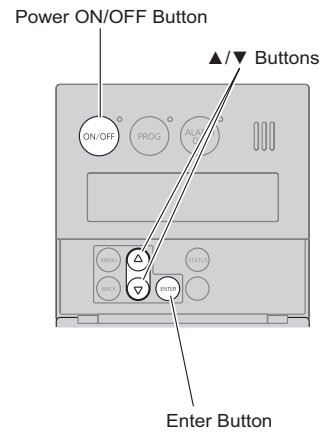

● Setting Procedure (example to change Item No. 1A)

- (1) Turn the water heater off by pressing the Power ON/OFF Button on the remote controller.
- (2) Turn OFF the power supply (disconnect electrical power to all heaters), then turn ON the power supply (reconnect electrical power to all heaters) and wait 10 seconds before proceeding to step (3).
- (3) Within the first ten minutes of connecting electrical power, before turning on the Power ON/OFF Button, press the ▲/▼ Buttons on the remote controller and hold until the display blinks "99". If "99" does not blink on the remote controller, disconnect electrical power to all heaters and try again.
- (4) Use the ▲/▼ Buttons on the remote controller to scroll to the item number "1A" on the column of the item.
- (5) Press the ENTER Button, "Item number" stops blinking and "Data state (OFF or ON)" will start blink.
Use the ▲/▼ Buttons on the remote controller to change OFF ↔ ON.
- (6) Change "1A" from OFF to ON.
* Do not adjust any other items!

Item	Data
▲/▼ 1A	ON

- (7) When the items has been set correctly, press the ENTER Button, "Data state (ON)" stops blinking and "Item number" will start blink. Confirm the setting by pressing and holding both the ▲/▼ Buttons on the remote controller until the controller emits a beeping noise.
The new setting will be lost if this is not done.
- (8) Disconnect Power to all heaters in the multi-unit system.
Wait 10 seconds or more, and reconnect power.

List of settings

Item #	Data Indication	
19	OFF (Two units fire at startup)*	ON (One unit fires at startup)
1A	OFF (Alarm for any system error)*	ON (Alarm only for system down error)





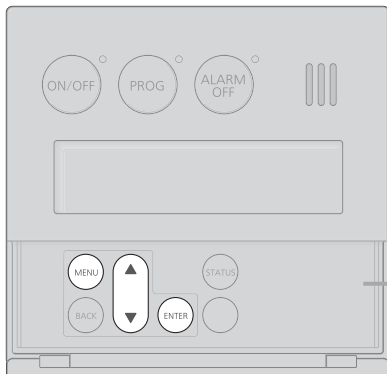

* Factory Default Settings

11. Additional Remote features

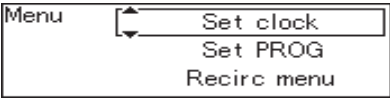
For All Systems Clock Adjustment

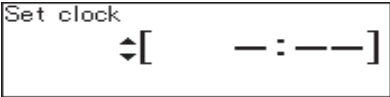

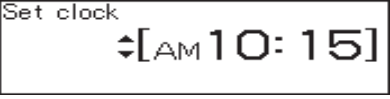
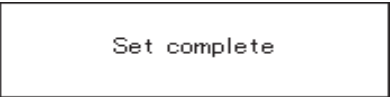
Cover shown in the open position.

Operation	Screen Display	Description
1 Press the  button inside the cover.		* This adjustment can be made regardless of whether the  button is ON/OFF.
2 Press the  button.		
3 <ol style="list-style-type: none"> Use the  buttons to adjust the clock. Press the  button to complete the clock setting. 	<ol style="list-style-type: none">  <p>(Ex: 10:15 am)</p>  <p style="text-align: center;">▼ The screen returns to the previous screen.</p>	* The time changes in 1-minute increments with each press of the button, and then in 10-minute increments if the button is kept pressed down. * If the display is left untouched for approximately 20 seconds without pressing the  button, the setting will be completed. When the  button is turned ON, the home screen will be restored.



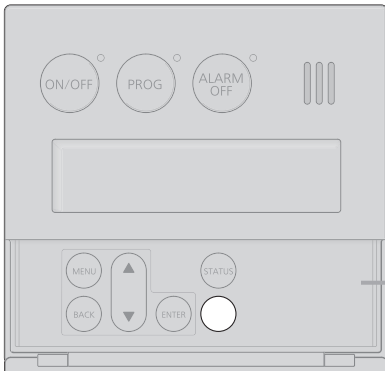





* In the event of a power outage or after disconnecting power to the water heater, when power is restored, the clock on the display screen will show " - : - - " and the clock will need to be reset.



Cover shown in the open position.

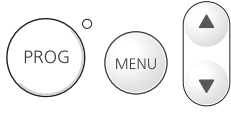

By locking the remote controller, the settings cannot be accidentally changed if a button is pressed by mistake.

Operation	Screen Display	Description
<p>1 Press and hold  button for approximately 2 seconds to lock the remote controller.</p>		<ul style="list-style-type: none"> * The operation can be locked regardless if the  button is "ON" or "OFF". * The operations of , , and  buttons are locked. * Approximately 3 seconds after locking the remote controller, the display will return to the previous screen.
<p>If you press these buttons</p>  <p>while the remote controller is locked, the "Locked" screen will appear.</p>		<ul style="list-style-type: none"> * Approximately 3 seconds after the "locked" screen appears, the display will return to the previous screen.

● To Unlock the Remote Controller

Press and hold  button for approximately 2 seconds to unlock the remote controller.

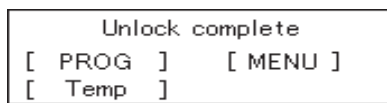

* Approximately 3 seconds after unlocking the remote controller, the display will return to the previous screen.

12. Remote Controller

Remote Controller (RC-7649M) with NC380-SV-ASME

- ◆ The remote controller will emit a tone when a button is pressed. This Remote Controller is not resistant to water, steam, chemicals, or UV rays. Install it in a location where it will not be exposed to these conditions. If it must be installed outdoors, use a weatherproof enclosure.
- ◆ Remote Controller (RC-7649M) : The displayed unit is [°F/gal (Fahrenheit/Gallon)].
- ◆ The displayed unit can be changed to [°C/L (Celsius/Liter)]. The factory default unit is [°F/gal]. To change the unit, refer to the page 25.

Remote Controller (RC-7649M)

What is actually displayed depends on how the water heater is set.

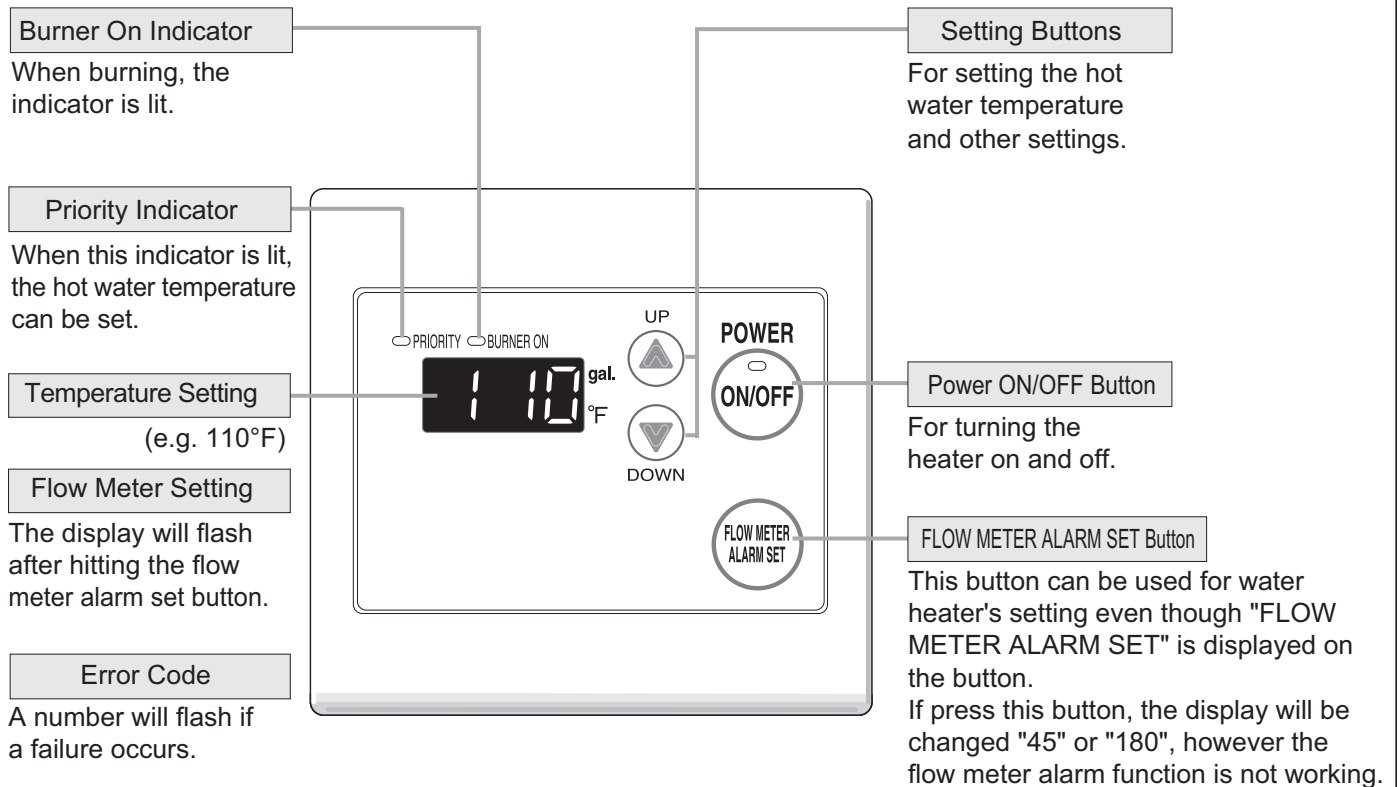

* Before use, remove the protective sheet from the remote controller surface.

Temperature Settings

Fahrenheit[°F]	100	105	110	115	120	125	130	135	140	145	150	160	170	180
Celsius[°C]	38	41	43	46	49	52	54	57	60	63	66	71	77	83

13. Remote initial setup

Remote Controller (RC-7649M) Initial Setting Procedure with NC380-SV-ASME

Note: When using remote controller RC-7649M, change the initial settings in accordance with the following instructions. If the settings are not changed, an error code "730" may appear on the Remote Controller.

● Setting Procedure

- (1) Turn the water heater off by pressing the Power ON/OFF Button on the remote controller and wait 10 seconds or more.
- (2) Turn OFF the power supply (disconnect electrical power to all heaters and System Controller), then turn ON the power supply (reconnect electrical power to all heaters and System Controller) and wait 10 seconds before proceeding to step (3).
- (3) Press the UP (▲) or DOWN (▼) buttons and then "99" code will blink on the display. The water heater system is on the initial setting procedure.

Note: If you press the Power ON/OFF Button, you can't change the initial setting. If fail to this procedure or "99" code does not blink on the display, disconnect electrical power for all water heaters and system controller. And then try step (1)-(3) again.

- (4) Press the UP (▲) or DOWN (▼) buttons and then scroll to "10", "11" and "1B".
 Change the "10", "11", and "1B" based on following table.
 Press the FLOW METER ALARM SET Button for more than 2 seconds to change the settings.
 - If each code is activated, the "PRIORITY" LED lights up.
 - If each code is deactivated, the "PRIORITY" LED lights off.

CAUTION: Do not change any item other than those listed.

Item #	Standard	Recirculation	Tank Recirculation
10	ON	OFF	ON
11	OFF	ON	ON
1B	ON	ON	ON

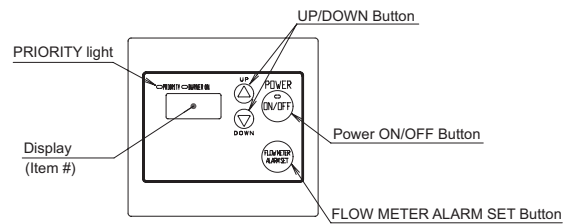

- (5) Press and hold the UP (▲) and DOWN (▼) buttons simultaneously for more than 2 seconds to complete the initial setting. Then you will hear a beep from the remote controller.
 Note: If no beep, the initial setting is not completed. In this case try step (1) - (4) again.

■ Change System Settings.

Use this procedure if you need to change the system settings after running the " Initial Setting Procedure " (page 21).

● Setting Procedure

- (1) Turn the water heater off by pressing the Power ON/OFF Button on the remote controller and wait 10 seconds or more.
- (2) Turn OFF the power supply (disconnect electrical power to all heaters), then turn ON the power supply (reconnect electrical power to all heaters) and wait 10 seconds before proceeding to step (3).
- (3) Press the UP (▲) or DOWN (▼) buttons and then "99" code will blink on the display. The water heater system is on the initial setting procedure.

Note: If you press the Power ON/OFF Button, you can't change the initial setting. If fail to this procedure or "99" code does not blink on the display, disconnect electrical power for all water heaters and system controller. And then try step (1)-(3) again.

- (4) Press the UP (▲) or DOWN (▼) buttons and then scroll to "14", "15" and "16".
Change the "14", "15", and "16" based on following table.
Press the FLOW METER ALARM SET button for more than 2 seconds to change the settings.
- If each code is activated , the "PRIORITY" LED lights up.
- If each code is deactivated, the "PRIORITY" LED lights off.

CAUTION: Do not change any item other than those listed.

List of the settings

Item #	Item in the Sys settings	System type			OFF	ON
		Standard	Recirc	Tank recirc		
14	Pump error check	Not Available	Available	Available	System will check for flow when system controller pump terminals are energized. If no flow is present, it will display 63 error code	System will not check for pump operation*
15	Pump rotation	Not Available	Available	Available	Pump 1 and 2 will operate simultaneously*	System will rotate pump 1 and 2 operation
16	125 °F recovery during high-temperature setting	Available	Available	Available	If the Power ON/OFF Button is turned OFF and ON, the unit will accept 125 °F return water (if the unit is set at that temperature or higher)	The unit will allow the standard return temperature*

*Factory Default Settings

- (5) Press and hold the UP (▲) and DOWN (▼) buttons simultaneously for more than 2 seconds to complete the initial setting. Then you will hear a beep from the remote controller.

Note: If no beep, the initial setting is not completed. In this case try step (1) - (4) again.

■ The system settings of SC-401 US must be the same as SC-201 US when replacing SC-201 US with SC-401.

The original system settings of SC-201 US are listed below.

List of the settings (SC-201 US)

DIP SW #	Item in the Sys settings	System type			OFF	ON
		Standard	Recirc	Tank recirc		
2	Pump error check	Not Available	Available	Available	System will not check for pump operation	System will check for flow when system controller pump terminals are energized. If no flow is present, it will display 63 error code*
3	Pump rotation	Not Available	Available	Available	System will rotate pump 1 and 2 operation	Pump 1 and 2 will operate simultaneously*
4	125 °F recovery during high-temperature setting	Available	Available	Available	If the Power ON/OFF Button is turned OFF and ON, the unit will accept 125 °F return water (if the unit is set at that temperature or higher)	The unit will allow the standard return temperature*

*Factory Default Settings

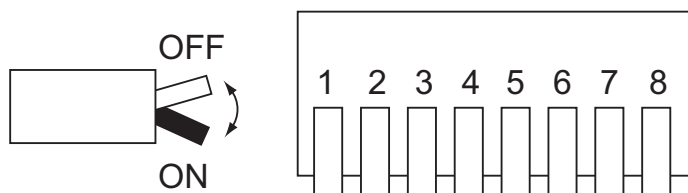

14. Additional Remote features

Following setting can be changed in addition to the system settings.
Note: Do not change anything other than following settings.

How to Use

Adjusting the Maximum Output Temperature

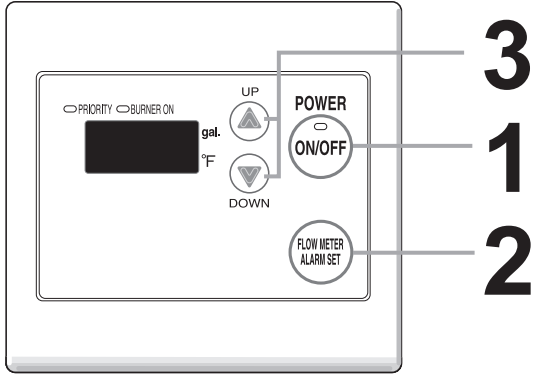

1 Turn off the power.

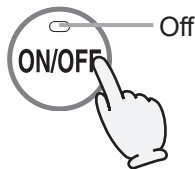

2 Press and hold the FLOW METER ALARM SET Button until a sound is heard (2 sec.).

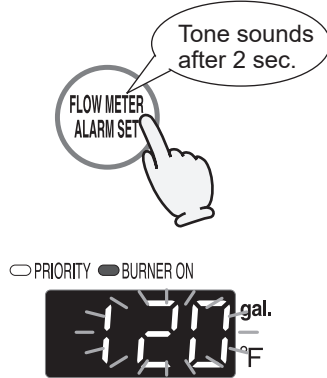

3 Change the temperature using the setting buttons.

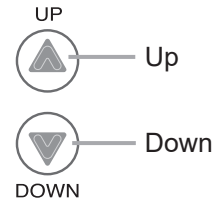

The upper limit of the hot-water supply temperature can be changed to

(For Fahrenheit (°F))
100 - 150°F (In 5°F intervals)
160°F, 170°F, 180°F.

(For Celsius (°C))
37 - 48°C (In 1°C intervals)
50 - 80°C (In 5°C intervals).

4 Set the Power ON/OFF button to ON when continuing to use the unit as is. Otherwise, let the unit sit for 30 sec.

Change the way the units of temperature and flow rate are displayed on the screen (standard vs. metric).

When using remote controller RC-7649M, select "[°F/gal] or [°C/L]" as following steps.
The default setting is "[°F/gal]"

■ Procedure for changing from [°F/gal] to [°C/L]

Adjusting the Temperature Display

Note: The setting must be done within the first 10 minutes of connecting electrical power to all the water heaters.

Table of Setting Items

Item No.	Item	Defaults Setting	
12	Celsius/Liter or Fahrenheit/Gallon display mode.	°F/gal (Fahrenheit/Gallon)	°C/L (Celsius/Liter)

■ Remote Controller

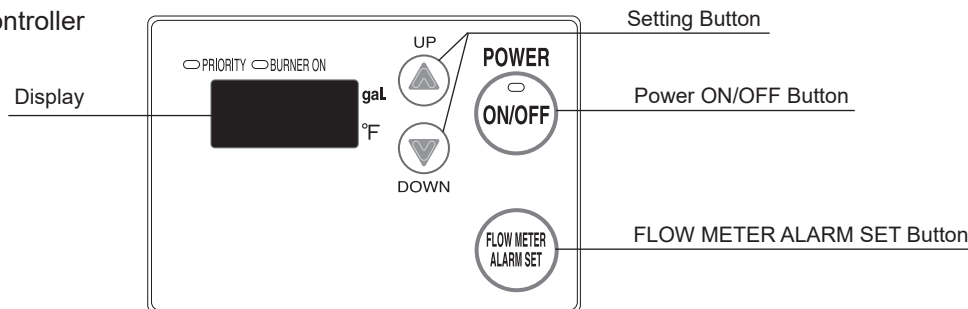

■ Setting Procedure

1. Turn the water heater off by pressing the Power ON/OFF Button on the remote controller and wait 10 seconds or more.
2. Disconnect, then reconnect electrical power to all the water heaters.
3. Press the FLOW METER ALARM SET Button and hold it in for 2 seconds or more.
4. Press the FLOW METER ALARM SET Button until the remote controller displays item number "12".
5. Press and hold the UP (▲) button for more than 5 seconds to change the display units to "[°F/gal]".

When set to [°F/gal], the display shows below.



6. Press and hold the DOWN (▼) button for more than 5 seconds to change the display units to "[°C/L]".

When set to [°C/L], the display shows below.



7. To confirm the setting, turn the water heater on by pressing the Power ON/OFF Button on the remote controller.
8. Wait 15 seconds or more.
9. Turn OFF the power supply (disconnect electrical power to all heaters), then turn ON the power supply (reconnect electrical power to all heaters).
10. Adjusting the Maximum Output Temperature (Page 24) and set temperature.

Note: In this case, even though the printed unit on the Remote Controller is [°F/gal], the displayed number on the display means [°C/L] and the water heater will be working under [°C/L].

Checking Recirculation Flow through Maintenance Monitors

NOTE) For proper recirculation operation, recirculation flow rate (total flow rate) must be verified to be more than 2.5 GPM.

1. Turn the power off by pressing the Power ON/OFF Button.
2. Press and hold the UP (▲) and DOWN (▼) buttons simultaneously for more than 2 seconds.
Now you are on the Maintenance Monitors mode.
Initially, a certain number will be displayed on the display, but ignore the number currently.
3. Turn the power on by pressing the Power ON/OFF Button. The power indicator (LED) will be on.
4. Press the FLOW METER ALARM SET Button. The "Unit No." will be changed whenever you press the button.
After pressing the FLOW METER ALARM SET Button, a certain number will be displayed on the display right away.
This number shows "Data No.". It is the sensing number via sensing item (e.g. Thermistor, Flow sensor).

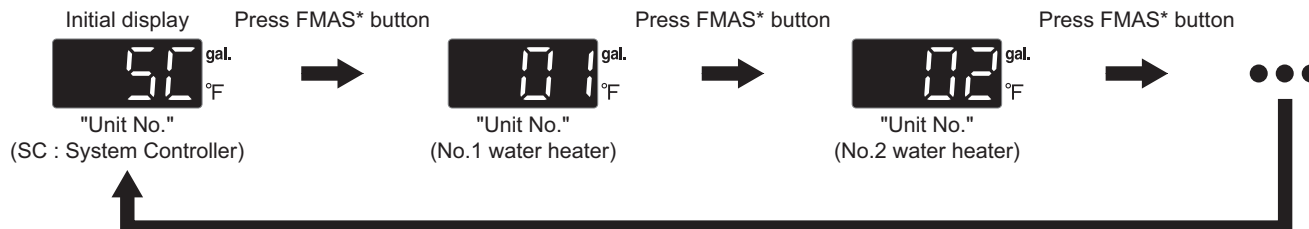

*FMAS : This means FLOW METER ALARM SET Button

5. In order to check the flow rate for each water heater, set the desired "Unit No." by pressing the FLOW METER ALARM SET Button, and then select "Data No. 14 (flow rate)" by pressing either UP (▲) or DOWN (▼) button.

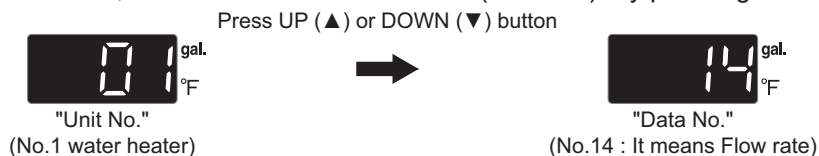

6. Make sure total recirculation flow* (Data No.14) 2.0 GPM (7.5 L/min) or more.

*e.g.) If two water heaters are operating, confirm the flow rate for each water heaters, then calculate the total flow from each water heater's flow rate.

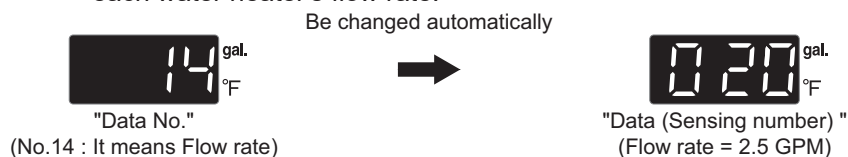

7. Press and hold the UP(▲) and DOWN(▼) buttons simultaneously for more than 2 seconds in order to return to the original mode (original display).

15. Additional System Controller Features

System Controller Terminals (Optional Connections)

Warning Light Terminal

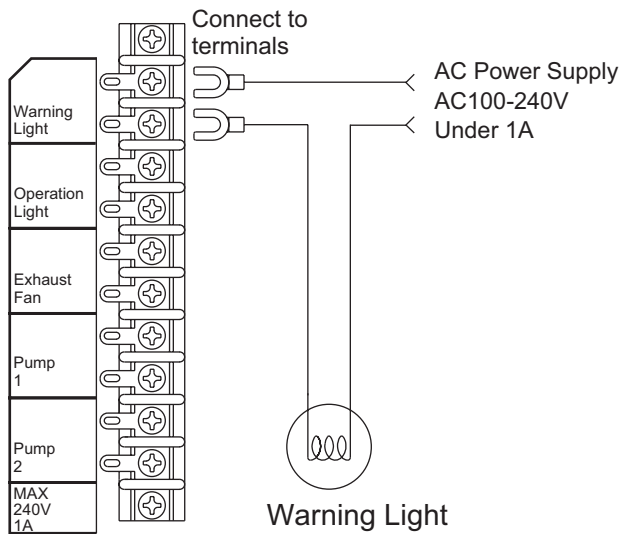

Operation Light Terminal

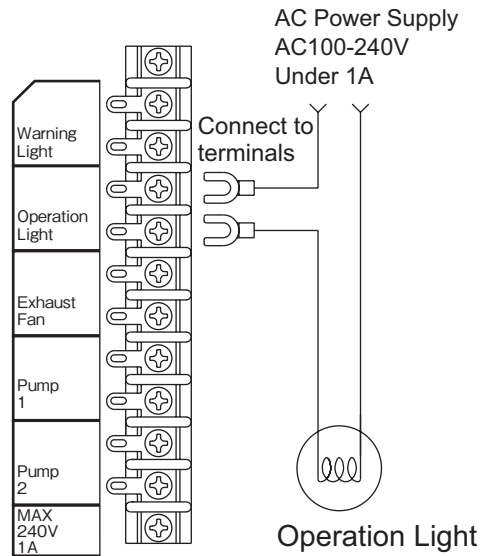

- If you make the connections as shown above, the light will turn on when a failure (error code) of any water heater in the system is generated. It will remain lit until the failure has been resolved. If the light turns on, the failure must be resolved after checking the remote controller for error code(s). The light will also turn on if the power supply to the system controller is cut off.

- If you make the connections as shown above, the light will turn on and remain on any time the system is turned on at the remote controller. If the power button is turned off at the remote controller, the light will turn off.

Circulation Pump Terminals 1,2

- Use these terminals to control the pumps in any circulating system. Connected this way, the system controller will control the function of the pumps. Use normally open relays (electromagnetic switches) to supply power to the pumps. Use thermal relays if necessary. Connect them when they are used for recirculation system or storage tank recirculation system.
- Use electromagnetic contactors / thermal relays suitable for the load.

1) When operating with 1 circulation pump

* If there is only one pump, connect to "Pump 1" terminals.

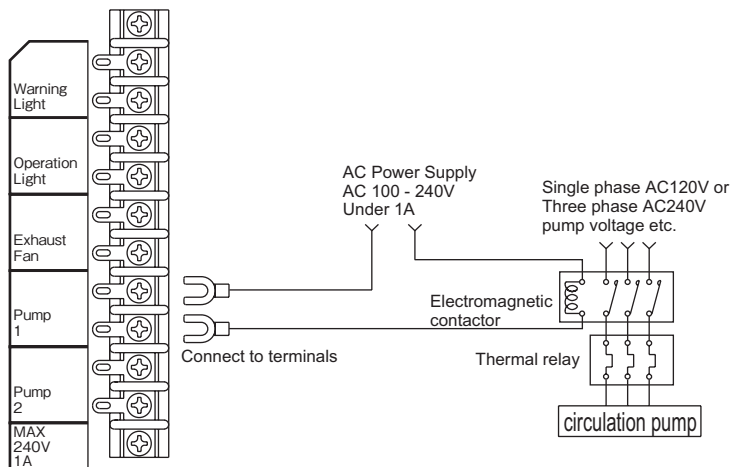

When you connect one circulation pump, set "No" for the question "Start pump rotation?" in the system settings. (refer to page 9,22.)

2) When operating with 2 circulation pumps

The system controller carries out the alternate operation of "pump 1" and "pump 2" at regular time intervals by connecting two circulation pumps.

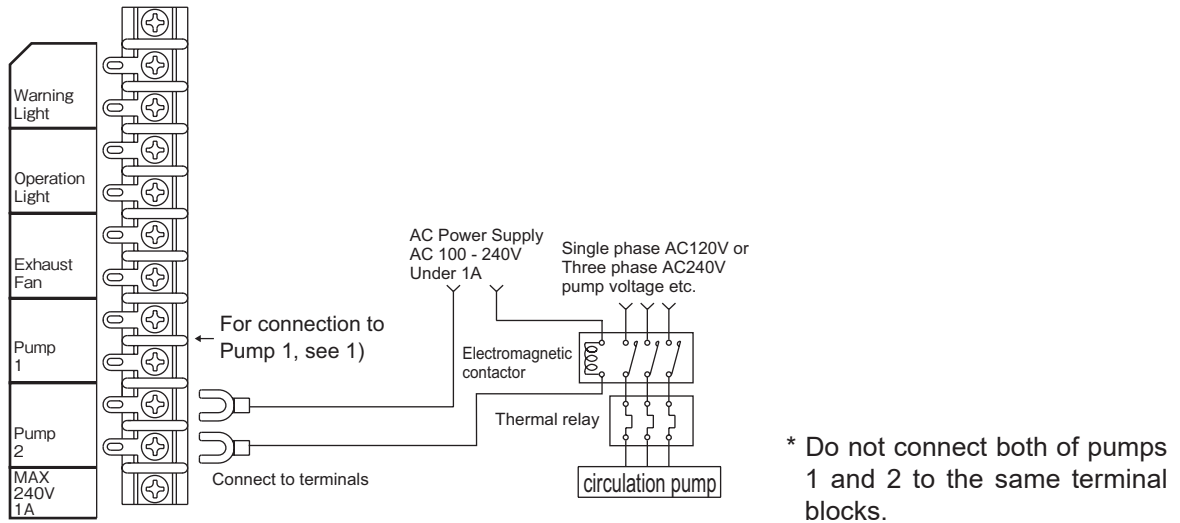

When you connect two circulation pumps, in the system settings. (refer to page 9,22.)

* Piping diagram for parallel pipe installation

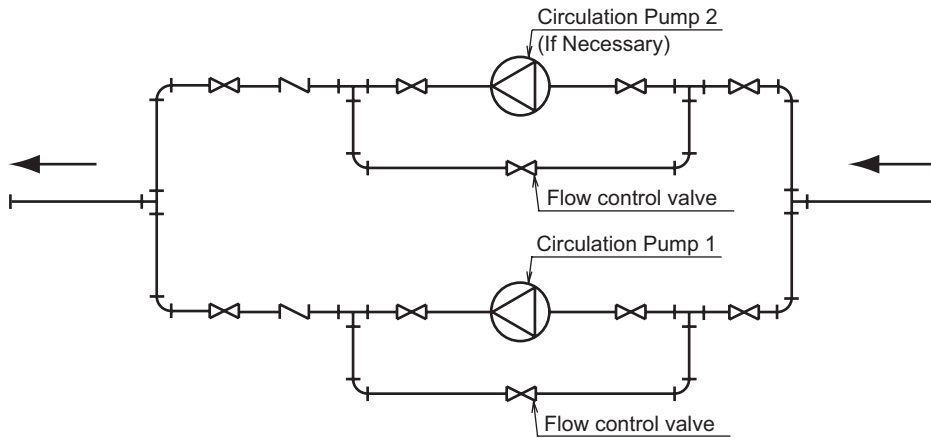

Adjust the pump flow with the flow control valves.
If multiple pumps are used, control the flow of each pump with separate valves.

Exhaust Fan Terminal

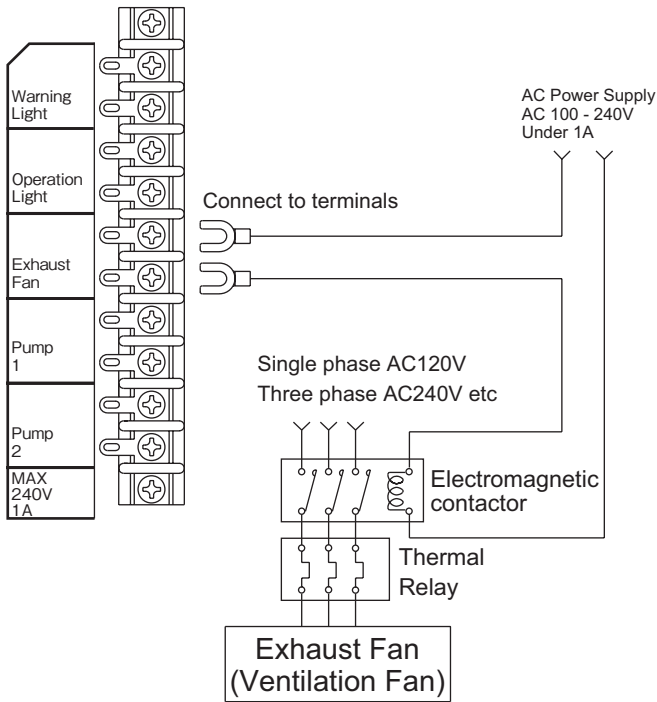

- These terminals will close when any of the units are firing or when the fan on any of the units is blowing. These terminals can be used to control an exhaust fan or damper in this way.
- Use a relay (electromagnetic contactor) to provide power to the fan or damper. Use an additional thermal relay if necessary.
- Use the electromagnetic contactor / thermal relay suitable for the load.

■ Connections of Pressure Switch, External Operation Switch, and Thermostat (input terminals)

* The input terminals are collected on the rear surface of the terminal block of the system controller.
Pull out the wires after checking the tags.

Connecting the Pressure Switch

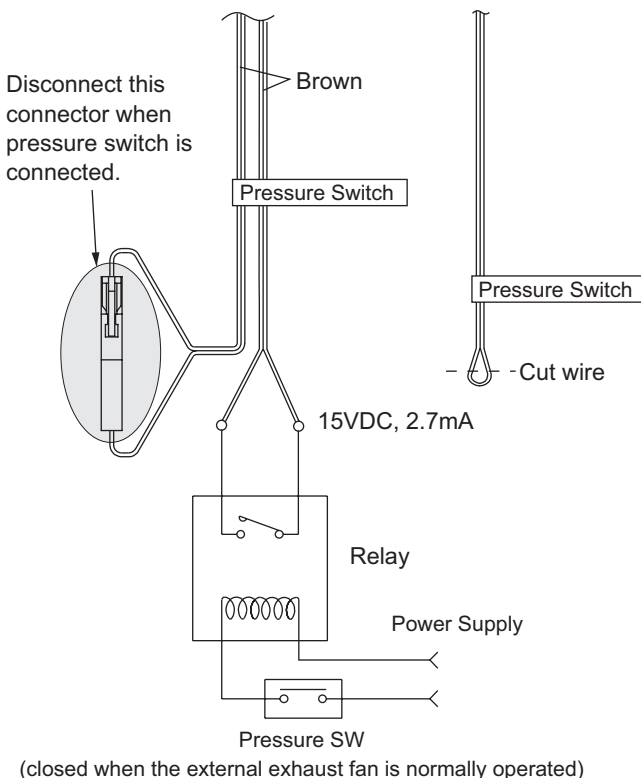

- A pressure switch or other item can be attached as a safety device when an external exhaust fan that is attached to the exhaust fan terminal above does not operate.
- If the status that a contact of the relay is opened continues, the system stops.
- Use the normally open relay with the contact for low voltage.
- This terminal is short-circuited when the product is shipped from factory. When you use this feature, cut a short-circuit electric wire and connect relay, and then disconnect a short-circuit connector.

Connecting the External Operation Switch

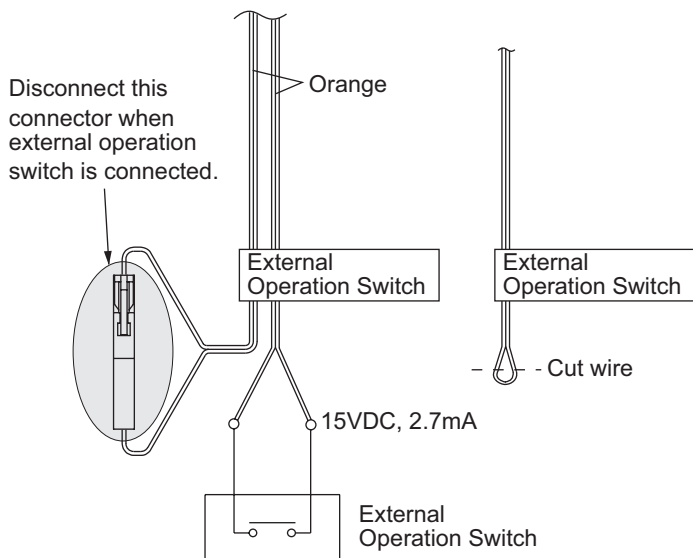

- Connect the external operation switch when you want to turn ON/OFF the water heater from external in addition to the Power ON/OFF Button of the remote controller.
- If the terminal of the external operation switch is switched from open to short, the Power ON/OFF Button of the water heater is turned "ON".
- If the terminal of the external operation switch is switched from short to open, the Power ON/OFF Button is turned "OFF".
- Use the normally open relay with the contact for low voltage.
- This terminal is short-circuited when the product is shipped from factory. When you use this feature, cut a short-circuit electric wire and connect the external operation switch, and then disconnect a short-circuit connector.

- For the external operation switch

- Whether the Power ON/OFF Button is synchronized or not to the cycle operation can be changed by switching the setting. (it can be changed only for recirculation system).

If the external switch is switched from open to short, the setting is switched as shown below.

Power ON/OFF Button is synchronized: Power ON/OFF Button is turned "ON", cycle operation is turned "ON"

Power ON/OFF Button is not synchronized: only Power ON/OFF Button is turned "ON"

Connecting the Thermostat

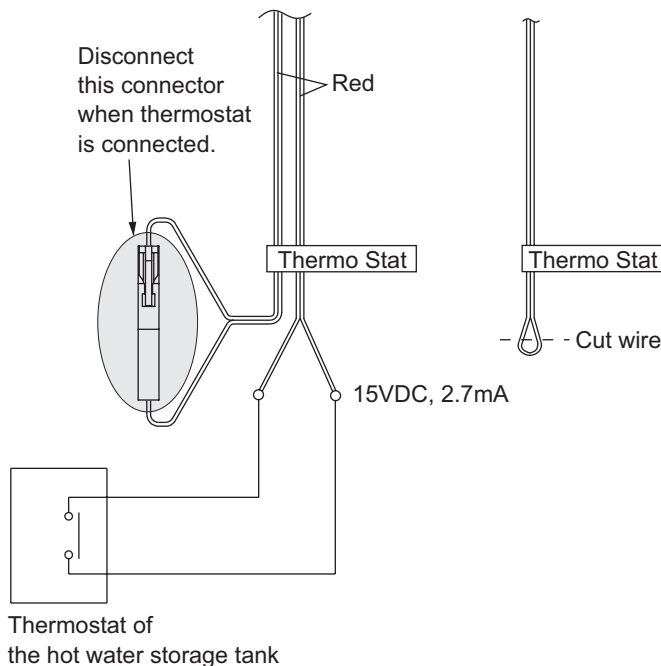

- Connect the thermostat of the hot water storage tank.
- If the temperature of the hot water storage tank exceeds the temperature set with the thermostat, the contact in the thermostat is opened and the circulation pump stops.
- A platinum resistance temperature detector cannot be connected directly.
- This terminal is short-circuited when the product is shipped from factory. When you use this feature, cut a short-circuit electric wire and connect the thermo stat, and then disconnect a short-circuit connector.

16. System design, Gas, and Water piping

■ System diagram (When six units are installed)

● Installation without a recirculation system (Standard System)

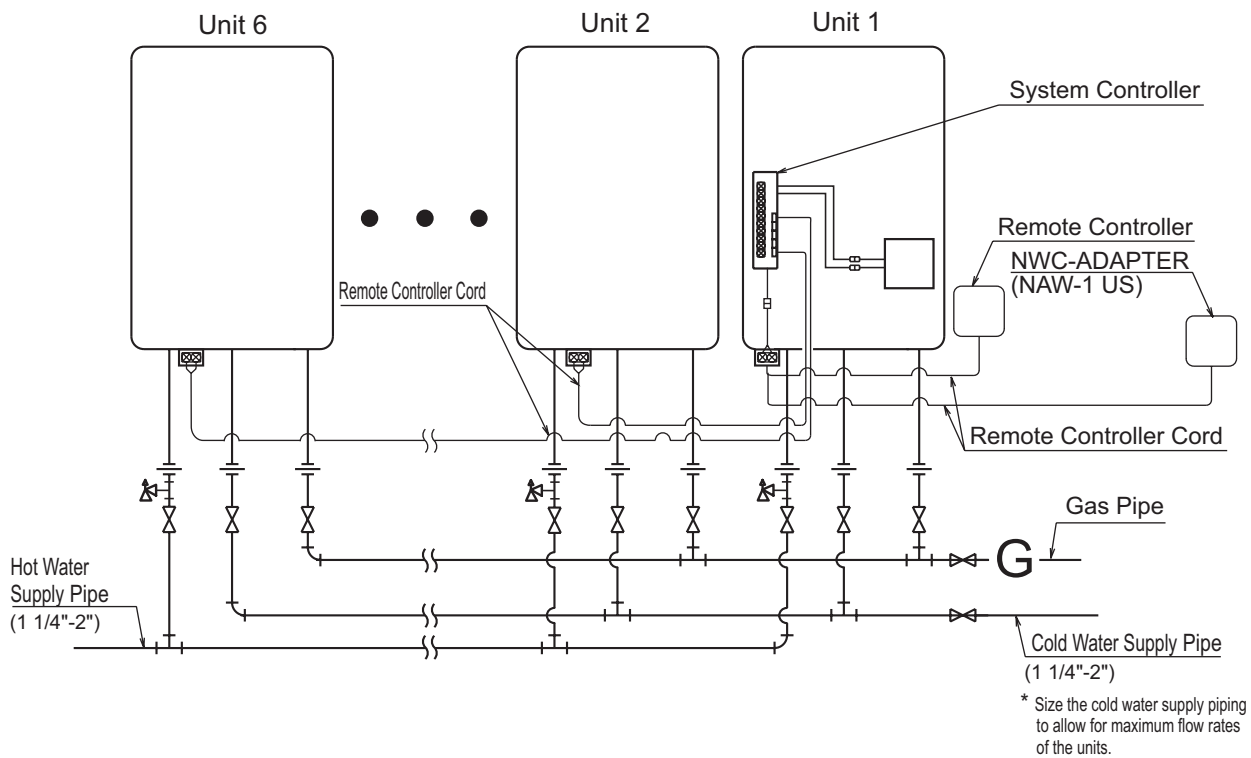

- Insulate or apply heating materials to both the cold water supply piping and the hot water supply piping to prevent freezing during cold weather and to prevent heat loss through the piping.

● Example of Recirculation with a Multi-unit System (Recirculation system)

This system will make hot water more quickly available to remote fixtures.

The pump will circulate water through the loop until the entire loop is warm, and then the system controller will turn off the pump until the loop cools down.

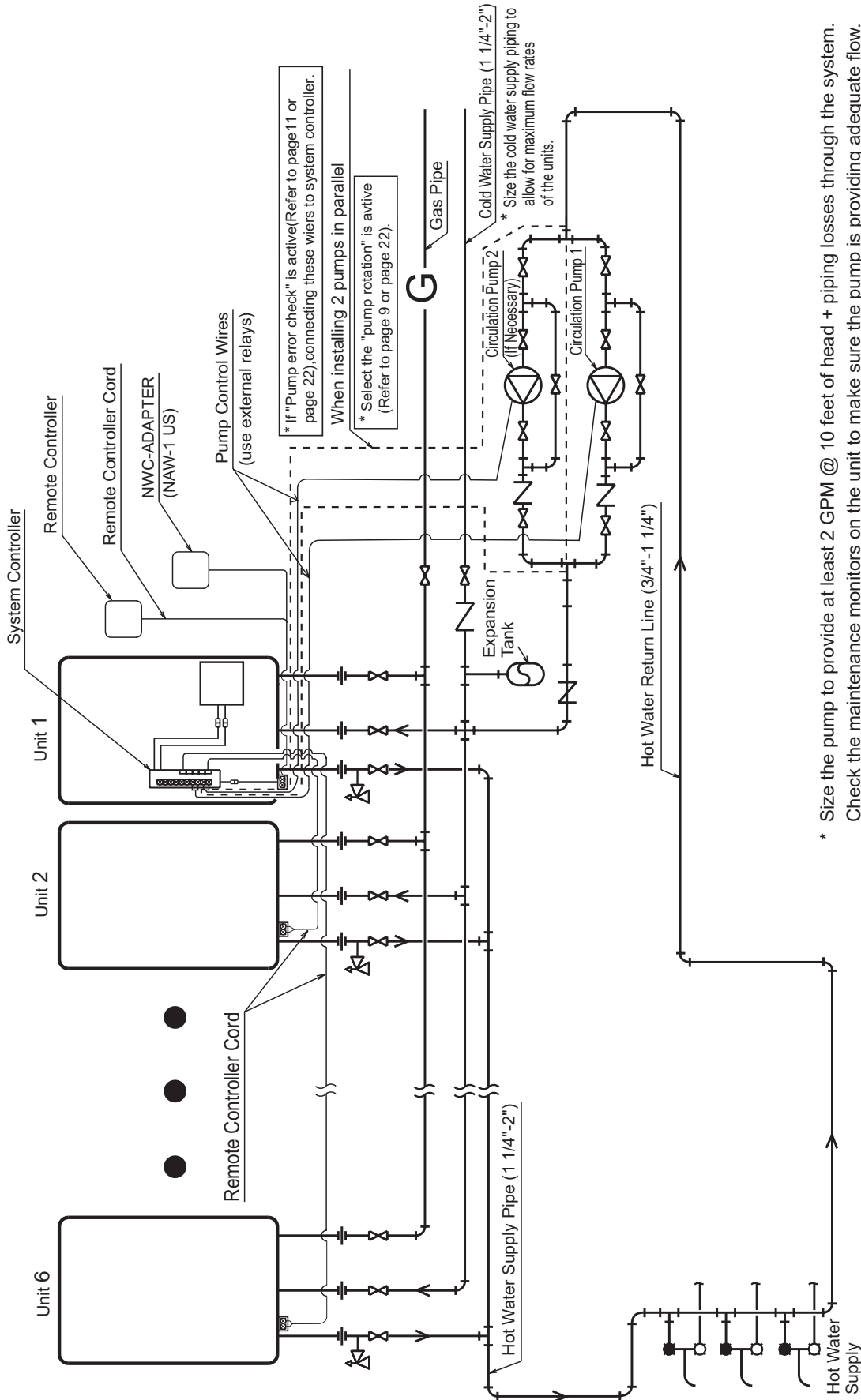

* Size the pump to provide at least 2 GPM @ 10 feet of head + piping losses through the system. Check the maintenance monitors on the unit to make sure the pump is providing adequate flow.

• Make sure that the flow rate is not greater than 4 ft./sec. (3/4": 5 GPM, 1 1/4": 13 GPM)

If the flow is too low, the recirculation loop temperature will not be warm enough, if the flow is too high, the lifetime of the unit will be reduced.

* If there are multiple circulation loops, try to make the flow rate .75-1.25 GPM in each loop.

* Use copper or stainless water piping for the entire system.

● Example of Installation with a Storage Tank and Recirculation System (Tank recirculation system)

The pump will push water through the Multi-unit System to heat up the tank.
 When the temperature of the thermostat is high, the system controller will turn off the pump until the temperature cools down.

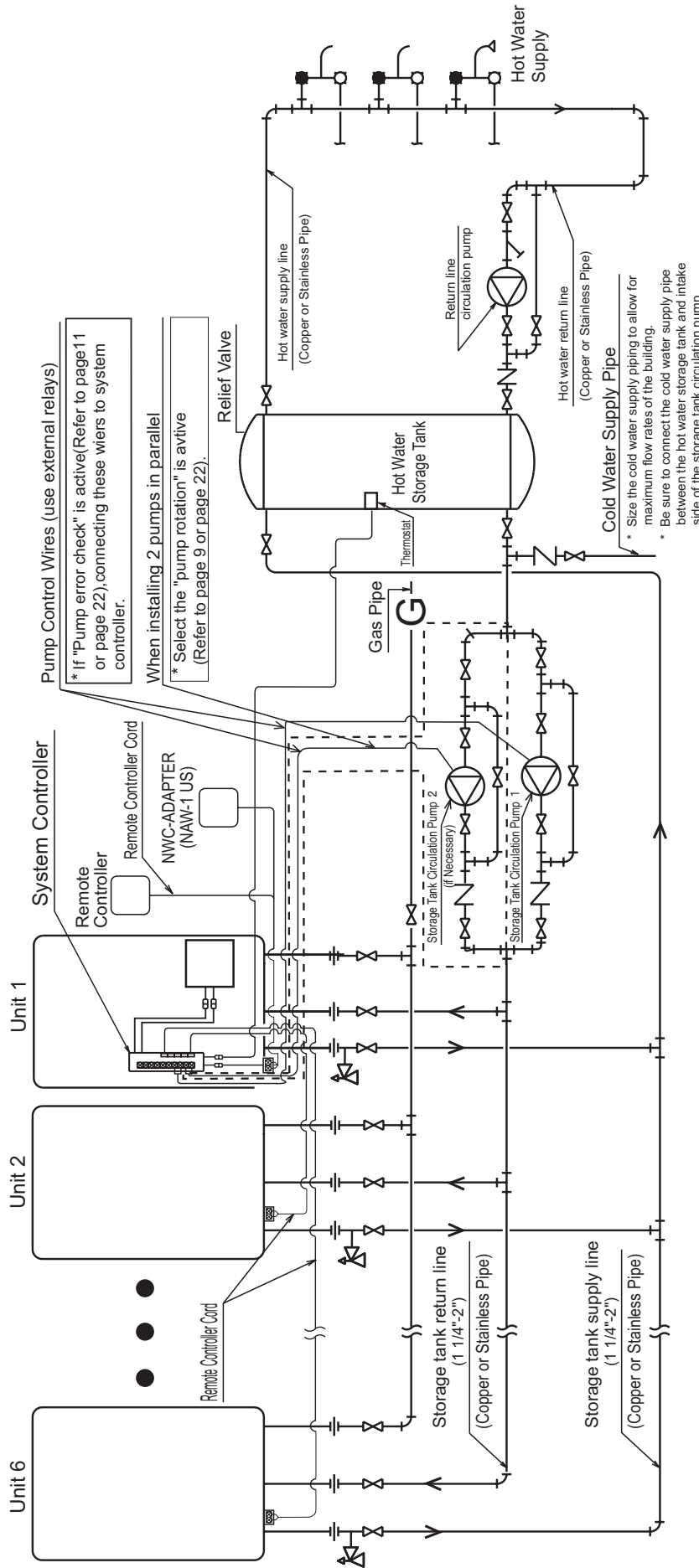

Pump Control Wires (use external relays)
 * If "Pump error check" is active (Refer to page 11 or page 22), connecting these wires to system controller.
 When installing 2 pumps in parallel
 * Select the "pump rotation" is active (Refer to page 9 or page 22).

* Size the cold water supply piping to allow for maximum flow rates of the building.
 * Be sure to connect the cold water supply pipe between the hot water storage tank and intake side of the storage tank circulation pump.

- * For the set temperature of the remote controller, use the temperature (of the thermostat) + about 10°F.
- * To achieve the highest recovery, size the storage tank circulation pump for maximum capacity. (9 GPM (each) @ 40 ft. of head (160°F setting or less) + piping losses through the system.) Verify the supply pressure to the units is at least 30 PSI.

■ Gas piping

* Follow the instructions from the gas supplier.

■ Gas connection

- Gas flex lines are not recommended unless they are sized for the maximum input kW (Btu/h • MJ) of each unit.
- Do not use piping with a diameter smaller than the size of the gas inlet to each unit.
- After installation, check the gas line for any leaks before using.

■ Gas Valve

Install a gas shutoff valve for every unit installed.

■ Gas Meter

Select a gas meter capable of supplying the entire kW (Btu/h • MJ) demand of all gas appliances that the meter serves. Size the gas line for the entire kW (Btu/h • MJ) demand also.

■ Water piping

* Ask a qualified plumber to perform the installation.

* Observe all applicable codes.

- The plumbing should be installed by a qualified plumbing contractor according to all applicable codes and regulations.
 - Insulate or apply heating materials to the supply and hot water piping to prevent freezing during cold weather and to prevent heat loss through the piping.
 - Use a union coupling or flexible pipe for connecting the units to ease service and maintenance.
 - Refer to the system diagrams for supply and hot water pipe sizing. Do not install piping that is smaller than the inlet or outlet water connections on the units.
 - If using an expansion tank, make sure it is correctly sized for the system.
 - Use only copper or stainless steel pipe for all plumbing.
 - Keep the plumbing as simple as possible.
 - Avoid using pipes in which air can accumulate.
- * Use only approved materials, and have the installation inspected upon completion.

17. Follow-up Service

■ Checking for Error Conditions

When a failure occurs, information relating to the error blinks on the display. The error alarm may also continuously sound.

Note: The combustion lamp will blink if any heater is in error alarm.

[RC-9018M]

- Error Code Display Screen

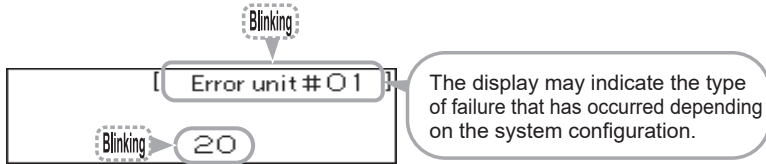

- To Stop the Error Alarm

Press the  button (the indicator will turn off).

[RC-7649M]

- Error Code Display Screen

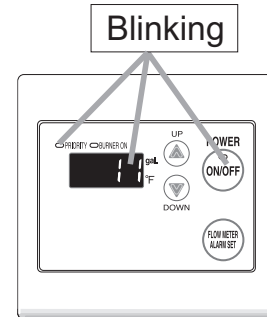



■ Requesting Service

- * Service and warranty periods are based on the type of product and the application type. Refer to the Limited Warranty provided with the water heater for complete details.
- * Refer to the "Troubleshooting" section in the Owner's Guide supplied with the water heater. If the problem is not corrected, contact Noritz America Technical Support at 866-766-7489 or visit <http://support.noritz.com/>.

Using RC-9018M



- Press the  button to check the status of the system

Operation	Screen Display	Description
1 Press the  button inside the cover.	<pre>System [Rrc] Active [04] Units [06] Pump1 [OFF] Online [04] Pump2 [ON]</pre> <Screen display (Example)>	* Status can be checked regardless of whether the  button is ON/OFF. * If the  button is pushed or it is left untouched for approximately 10 minutes, it will return to the previous screen.

• Identifying units that require service (system dependent).

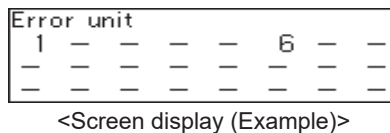
Press the  button twice inside the cover.



* If you press the  button, the screen of step 1 is displayed.
 If you press the  button, the screen returns to the previous screen.

If at any time during the installation and setup of this product you have questions or concerns, contact Noritz America at 866-766-7489 or visit <http://support.noritz.com/>.

Procedure for replacing System Controller

Included parts

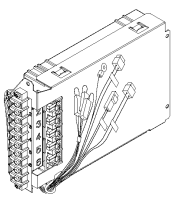
Parts	Qty	Shape(System Controller)
System Controller	1	
Installation Manual	1	
Procedure for replacing System Controller (This sheet)	1	

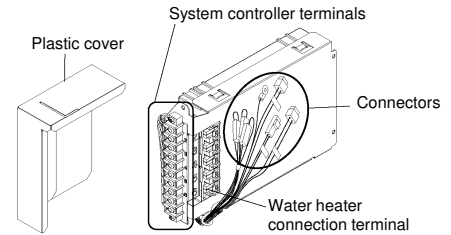

Figure 1: System controller and Plastic cover

Before replacing the System Controller, be sure to read this sheet and System Controller Installation Manual for correct operation.

Make sure your replacement situation as following case (1) or case (2):

(Case 1) Only the system controller is replaced.

(Case 2) Both the system controller and remote controller (RC-9018M or RC-7649M) are replaced at the same time.

(Case 1) When only the system controller is replaced.

- 1) Verify if any options (e.g. Warning Light, Operation Light, Circulation Pump, Exhaust Fan) are utilized (Figure 1). If in use, disconnect the electric power for all options being used.
- 2) Turn off power on/off button first, then disconnect the electrical power for all water heaters.
- 3) Replace the system controller.

1. Remove the plastic cover (Figure 1)

2. Disconnect all wires* to the system controller.

* Disconnect all additional wires for each optional item (Figure 1).

* Disconnect all connectors from the system controller (Figure 1).

* Disconnect all communication cords from the water heater connection terminals (Figure 2).

3. Put the original plastic cover on the new system controller.

4. Install the new system controller* into the water heater.

* Refer to pages 4 - 6 of the System Controller Installation Manual for detail installing way.

* Reconnect all wires and connectors to the new system controller.

Refer to pages 27 - 30 of the System Controller Installation Manual for the way to connect additional wires.

4) Connect the electrical power, and then turn on all water heaters.

5) When using remote controller RC-9018M, refer to step (6) to (9) procedure below.

When using remote controller RC-7649M, follow instructions on pages 21-23 of the System Controller Installation Manual.

Then proceed directly to step 8).

6) Wait for approximately 30 seconds, and then set the clock* of the remote controller.

* Refer to page 18 of the System Controller Installation Manual for setting the clock.

* If the system settings screen (Figure 3) is displayed, discontinue this procedure and refer to step 6) to 11) in the (Case 2) procedure below to complete the programming correctly.

7) If you want to set the recirculation system operation timer, set the timer in accordance with the System Controller Installation Manual.

* This timer is only available for the recirculation system. Refer to pages 13 to 14 of the Installation Manual.

8) Reconnect any options (e.g. Warning Light, Operation Light, Circulation Pump, Exhaust Fan) (Figure 1) disconnected from step 1).

9) The replacement is complete.

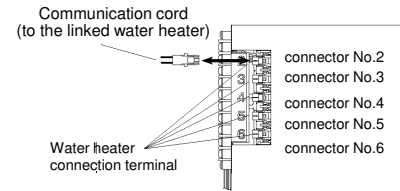

Figure 2: Water heater connection terminal

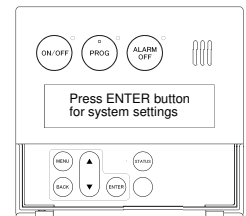

Figure 3: System settings screen

(Case 2) When system controller and remote controller (RC-9018M or RC-7649M) are replaced at the same time

1) Verify if any options (e.g. Warning Light, Operation Light, Circulation Pump, Exhaust Fan) are utilized (Figure 1). If in use, disconnect the electric power for all options being used.

2) Turn off power on/off button first, then disconnect the electrical power for all water heaters.

3) Replace the system controller and the remote controller (RC-9018M or RC-7649M).

1. Remove the plastic cover (Figure 1)

2. Disconnect all wires* to the system controller.

* Disconnect all additional wires for each optional item (Figure 1).

* Disconnect all connectors from the system controller (Figure 1).

* Disconnect all communication cords from the water heater connection terminals (Figure 2).

3. Put the original plastic cover on the new system controller.

4. Install the new system controller* into the water heater.

5. Replace the remote controller which is located on the #1 unit in the system.

* Refer to pages 4 - 6 of the System Controller Installation Manual for detail installing way.

* Reconnect all wires and connectors to the new system controller.

Refer to pages 27 - 30 of the System Controller Installation Manual for the way to connect additional wires.

4) Connect the electrical power, and then turn on all water heaters.

5) When using remote controller RC-9018M, refer to step 6) - 11) procedure below.

When using remote controller RC-7649M, follow instructions on pages 21 - 25 of the System Controller Installation Manual.

Then proceed directly to step 10).

6) In approximately 10 seconds, the system settings screen (Figure 3) is displayed on the remote controller.

Set up initial setting in accordance with the screen.

* Refer to page 9 - 10 of the System Controller Installation Manual for some parameter settings.

7) If necessary, set the miscellaneous system selection.

* Refer to pages 10 - 12 and 17 of the System Controller Installation Manual.

8) Set the clock* of the remote controller.

* Refer to page 18 of the System Controller Installation Manual for setting the clock.

9) If you want to set the recirculation system operation timer, set the timer in accordance with the System Controller Installation Manual.

* This timer is only available for the recirculation system. Refer to pages 13 to 14 of the Installation Manual.

10) Reconnect any options (e.g. Warning Light, Operation Light, Circulation Pump, Exhaust Fan) (Figure 1) disconnected from step 1).

11) The replacement is complete.