

MaxLite® Air Purifier (AP215SF3B)



**Contents**

1 Safety Precautions.....2-3

1B. FCC SDoc Statement.....4

2 Product Introduction.....5  
Description about the function of the control panel.....5

3 Before Use.....6  
Removal and installation method of bottom cover plate...6  
Place for air purifier.....6  
Install the filter.....7  
Understand the function of filter.....8  
Multiple functions.....8  
Unique triple purification technology.....8

4 Using Method.....9  
Description about the function of the control panel.....9  
Start the purifier.....10  
Manual mode.....10  
Wind speed setting.....10  
Sleeping function.....10  
Child lock function.....10  
Timing setting.....10

5 Maintenance and Cleaning Methods.....11  
Clean the air purifier.....11  
Replace the filter.....12  
Operation steps.....12-13  
When it is unused for a long time.....13  
Reference time for replacement of filter.....13

6 Fault Handling.....14  
Warranty and service.....15  
Ordering parts or accessories.....15  
Accessories.....15

7 Other Information.....15  
Recycling.....15

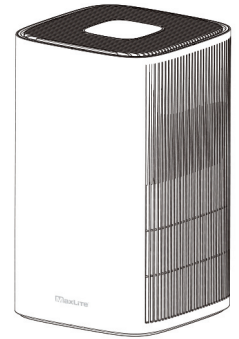

Picture is for illustration purposes only. Your model may vary.

# MaxLite® Air Purifier (AP215SF3B)



## 1: Safety Precautions

Please pay attention to the following safety precautions to avoid the possibility of damage to you or others.

**Note:** If the power cord is damaged, it must be replaced by professionals or the manufacturer in order to avoid danger.

**▲ WARNING**



**Please don't touch the power plug with wet hands.**  
Otherwise, it may cause electric shock.



**Please be sure to disconnect the power supply before cleaning the electrical appliances.**

Otherwise, the air purifier may suddenly operate, resulting in an electric shock accident.



**Please don't use the power supply or connected equipment exceeding the specified values.**

**Only 120V~ power can be used.**  
The use of universal sockets or equipment exceeding the specified value may lead to overheating and fire accidents.



**Please fully plug-in the plug into the socket before starting the air purifier. If the plug is not fully plugged into the socket, it may lead to electric shock, overheating and even fire accidents.**

- Please don't use the damaged plug or a loose power socket.



**Please don't damage the power cord and socket.**

Please don't bind wires when using this product. The use of damaged wires or sockets might result in electric shock, short circuit or fire accidents.

- Please don't cut, refit, excessively twist, twist, and pull wires, or place heavy objects on wires or sockets.



**Please clean the power plug regularly.**

If dust accumulates on the power plug, its moisture may damage the insulation part of the plug, resulting in a fire accident.

- Unplug the power plug and wipe it clean with a dry cloth (please don't use a wet cloth!).
- If the electrical appliance is not used for a long time, the power plug should be unplugged.



**Please don't disassemble or refit this air purifier without authorization.**

Unauthorized disassembly or refitting of electrical appliances may lead to electric shock, failure or fire accidents.



**Please don't place rods or other metal objects in air outlets or openings.**

Otherwise, it may touch internal parts and cause electric shock or damage.

## MaxLite® Air Purifier (AP215SF3B)

**1: Safety Precautions****⚠ CAUTION**

- Please disconnect the power to the product first if you need to move the product.
- Please be sure to move slowly while moving the instrument.
- Please don't move the product by pulling the power cord.
- Please don't move while the product is running. If you need to move the product, turn off the power.

**Please cut off the power supply of the product immediately in case of the following situations:**

- A switch does not work.
- The circuit breaker trips or the fuse burns out.
- The power line or plug is abnormally hot.
- A burning smell or any abnormal sound or vibration.
- Other faults or abnormal phenomena.



**Please don't use solvents such as benzene or diluent to clean the air purifier and avoid contact with insecticidal spray.**

Otherwise, the air purifier may rupture and cause damage or even a short circuit, resulting in electric shock or fire accidents.



**Please hold the plug and not pull the wire while unplugging the power plug.**

If the wire is pulled directly, it may cause a short circuit or damage the wire. This could lead to fire or electric shock.



**Please don't use this air purifier in rooms with fumigation insecticides.**

Otherwise, chemical residues may accumulate in the product and then be released from the air outlet which could endanger health.

- After using insecticides, the room should be thoroughly ventilated before using this air purifier.



**Please don't use this air purifier in places with high temperature and humidity or other places that will wet the housing, such as bathrooms.**

Air purifiers may experience power leakage and cause electric shock or fire accidents.



**Please don't wet the product housing.**

(Otherwise, it may cause fire disaster and electric shock due to a short circuit).



**Please don't allow volatile substances or combustible substances, such as tobacco or sparks, to float into the instrument.**

Otherwise, it may lead to fire accidents.

## MaxLite® Air Purifier (AP215SF3B)



1, READ AND SAVE THIS INSTRUCTIONS

2, This appliance has a polarized plug (one blade is wider than the other). To reduce the risk of electric shock, this plug is intended to fit in a polarized outlet only one way. If the plug does not fit fully in the outlet, reverse the plug. If it still does not fit, contact a qualified electrician. Do not attempt to defeat this safety feature.

3, WARNING: To Reduce The Risk Of Fire, Electric Shock Or injury To Persons, Do Not Use Replacement Parts That Have Not Been Recommended By The Manufacturer (e.g. Parts Made At Home Using A 3D Printer).

### **1B: FCC SDoc Statement**

This device complies with part 15 of the FCC Rules. Operation is subject to the following two conditions: (1) This device may not cause harmful interference, and (2) this device must accept any interference received, including interference that may cause undesired operation. Warning: Changes or modifications to this unit not expressly approved by the party responsible for compliance could void the user's authority to operate the equipment. NOTE: This equipment has been tested and found to comply with the limits for a Class B digital device, pursuant to part 15 of the FCC Rules. These limits are designed to provide reasonable protection against harmful interference in a residential installation. This equipment generates, uses and can radiate radio frequency energy and, if not installed and used in accordance with the instructions, may cause harmful interference to radio communications. However, there is no guarantee that interference will not occur in a particular installation. If this equipment does cause harmful interference to radio or television reception, which can be determined by turning the equipment off and on, the user is encouraged to try to correct the interference by one or more of the following measures: —Reorient or relocate the receiving antenna. —Increase separation between the equipment and receiver. —Connect the equipment into an outlet or circuit different from that to which the receiver is connected. —Consult the dealer or an experienced radio/TV technician for help.

# MaxLite® Air Purifier (AP215SF3B)



## 2: Product Introductions & Functions

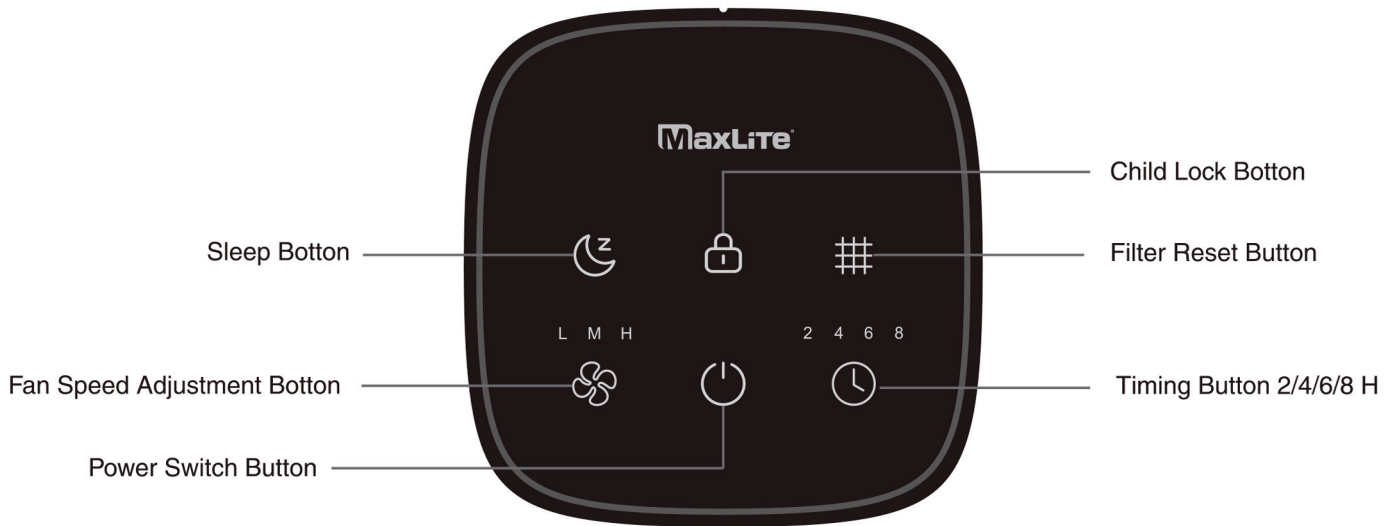
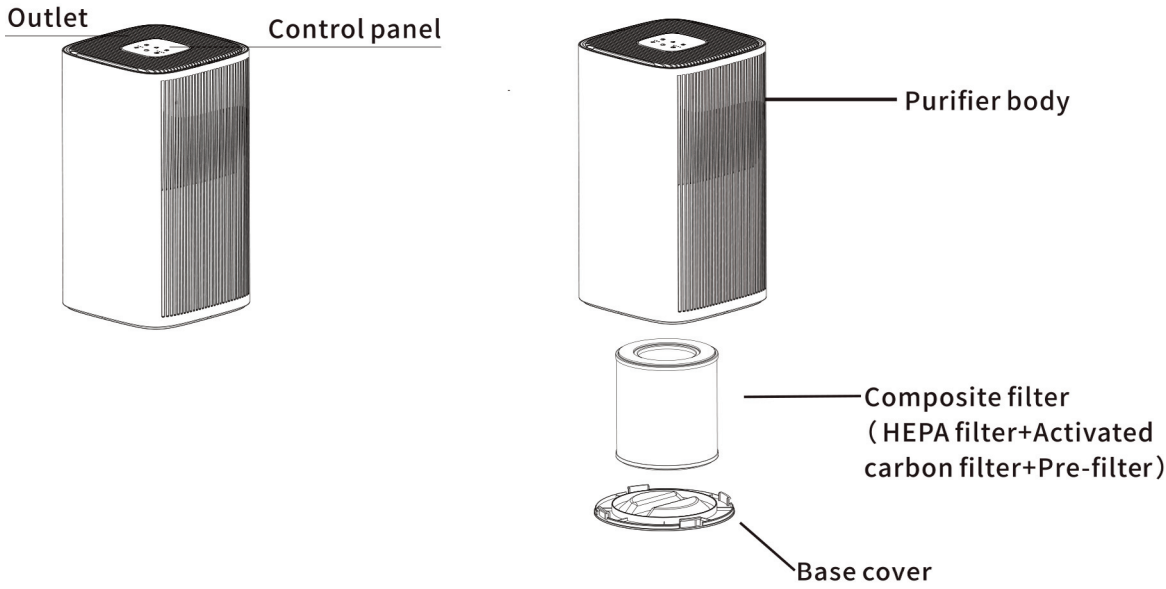

# MaxLite® Air Purifier (AP215SF3B)



## 3: Before Use

### Removal and installation method of bottom cover plate:

#### 1. Removing bottom cover:

Press the indicator button to unscrew the bottom cover

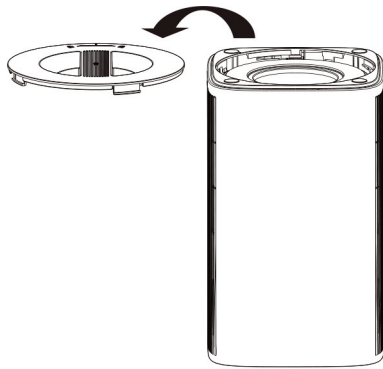
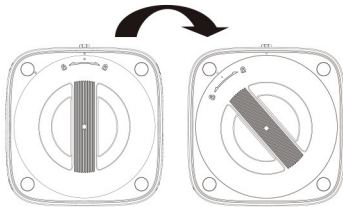

#### 2. Installing bottom cover:

To reinstall bottom cover align the unlock button and tighten in the locking direction.

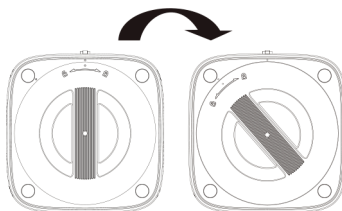

### Choosing a suitable place for the air purifier:

Make sure that the air inlet and air outlet of the instrument are not less than 20cm away from obstacles in order to make the air in your room circulate well.

Use it more than 1 meter away from TV, radio and other electrical appliances.

Please don't plug the power plug into the same socket with the power plug of TV, radio and other electrical appliances.

- If it is placed in the same place for a long time, it will sometimes dirty the walls around the host.

- Please don't interfere with the air inlet and air outlet to ensure that the product has sufficient ventilation and maximum efficiency.

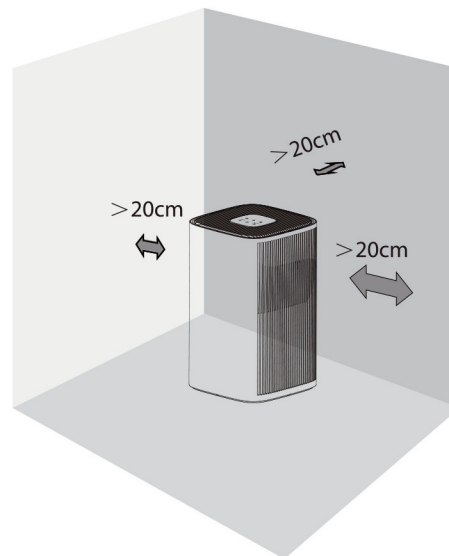

# MaxLite® Air Purifier (AP215SF3B)



## 3: Before Use

### Install the filter:

The interior of this air purifier is equipped with a filter, but **the packaging of the filter must be removed before using the product. Remove the filter and its packaging according to the following instructions, and then put it back into the purifier.**

### ⚠ CAUTION

- Please ensure that the power plug is installed, repaired and transported when the power supply is disconnected.
- Please don't operate product without a filter.
- **Please remove the plastic packaging of the filter before use.**

### Operation steps:

Please follow the following steps to correctly install the filter when using the air purifier for the first time.

1. Remove all packaging materials and place the instrument on a dry, stable and horizontal surface.

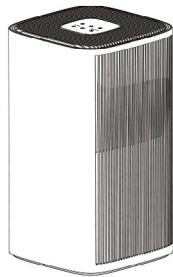

2. Press the bottom cover with your fingers and screw it out in the unlocking direction while taking out the bottom cover upward.

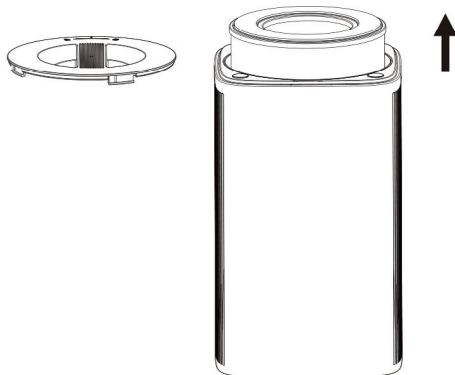

3. Remove the filter inside the purifier.

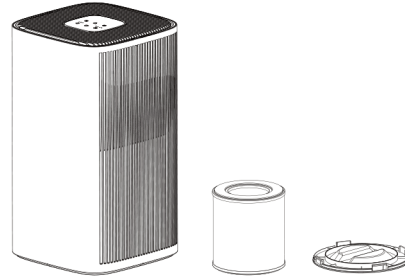

4. Remove the packaging material of the filter.

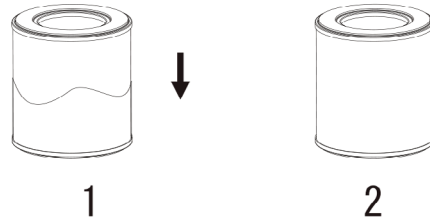

5. Put the filter back into the purifier.

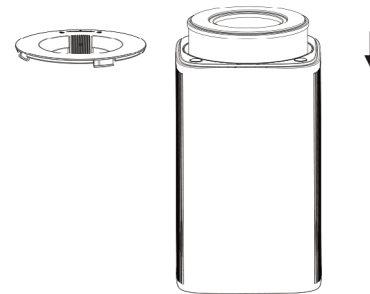

6. Press the indicator button to place the bottom cover and tighten it.

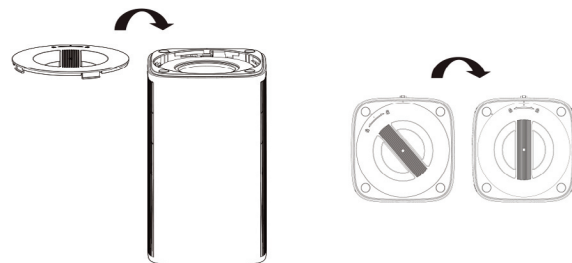

**Note:** Be careful not to pinch hand when installing the bottom cover.

# MaxLite® Air Purifier (AP215SF3B)



## 3: Before Use

### Understanding the filter function:

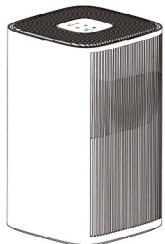
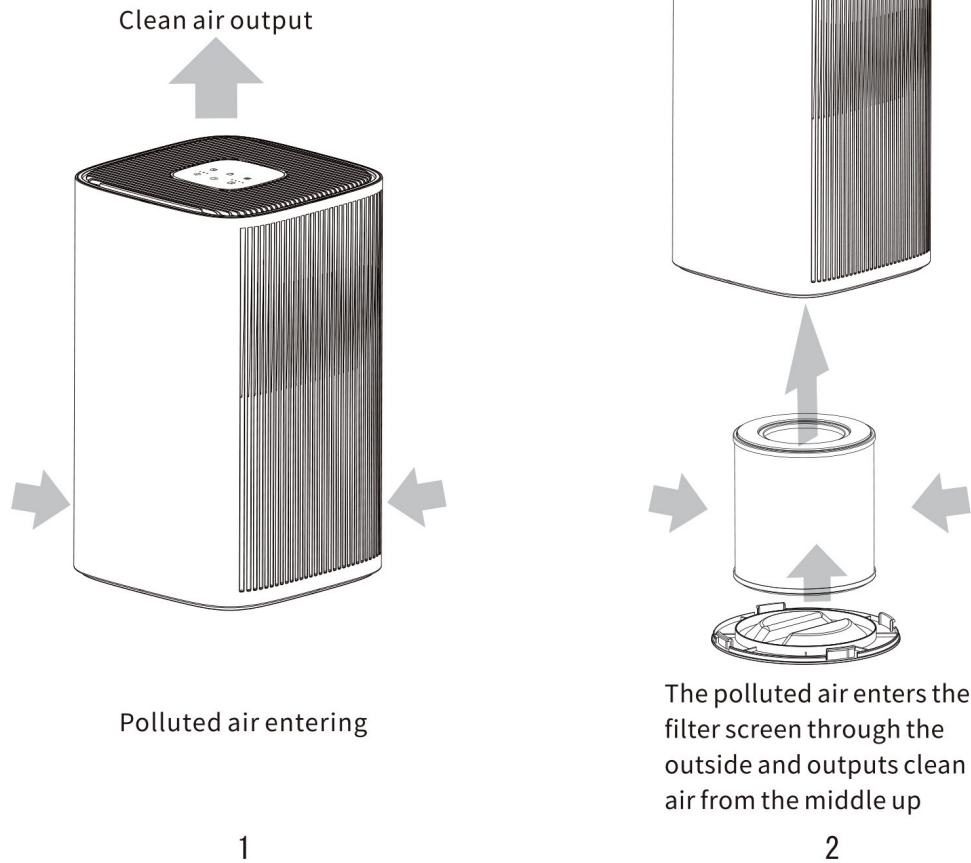

### Multiple Functions:

- Formaldehyde removal
- 4 wind speed switch
- Timer setting
- Prompt to replace the filter
- Configured with manual, sleep and child lock operation modes



The primary filter screen	Intercepts hair, fiber, large particles, dander, etc;
HEPA	Efficient removal of particulate matter such as filter, smoke and pollen.
High quality modified activated carbon	High quality activated carbon, modified by special proprietary technology, can effectively purify formaldehyde and other gas pollutants.

# MaxLite® Air Purifier (AP215SF3B)



## 4: Using Method

Description of control panel functions:

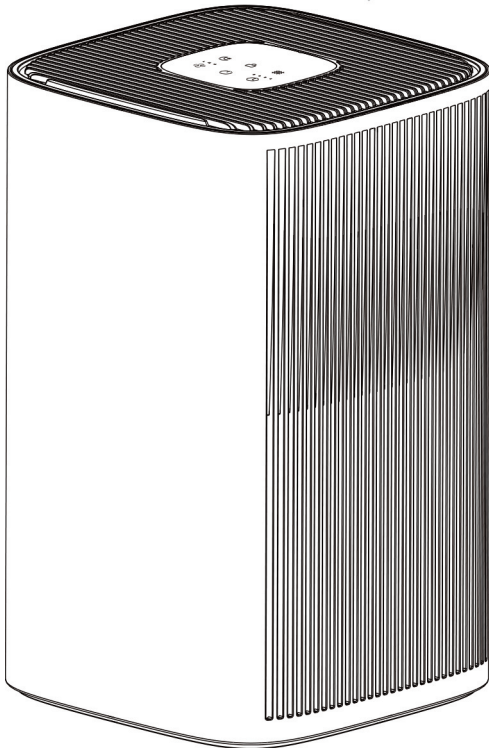
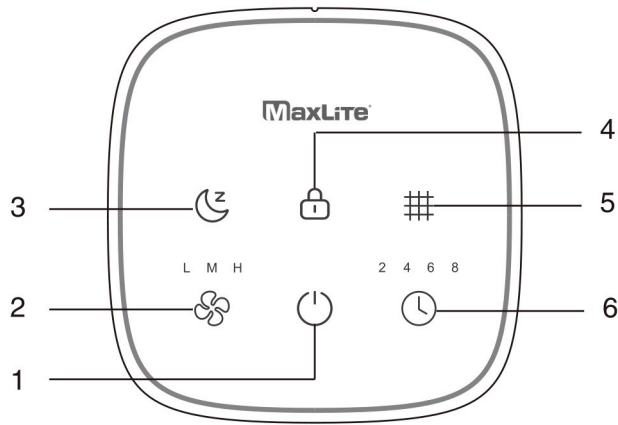

- 1** Power Switch Button
- 2** Fan Speed Indicator (Low-Medium-High)
- 3** Sleep Button
- 4** Child Lock Button
- 5** Filter Indicator/Reset Button
- 6** Timing Button (Timer 2/4/6/8 hours indicator)

**Plug in power supply:**

All the indicator lights will be on, then half on, and the product will enter the standby state.

# MaxLite® Air Purifier (AP215SF3B)



## 4: Starting the Purifier



When the power is plugged in, all the indicators will be on, then the power indicator will be half on, and the machine will enter the standby mode.

The product adopts a fan system composed of DC BLDC and centrifugal fan and air duct to make the indoor air circulation flow, the polluted air passes through the air filter inside the machine (HEPA)

**Note:** Pressing the on/off button again will turn off the product. After turning off you can unplug the power plug of the product.

### Manual Mode:



After power-on, the air purifier is in a standby state. Press the on/off button to start the air purifier and enter manual mode.

### Fan Speed Setting:



Press Fan button, the fan speed will change circularly from Low, Medium, High.

### Sleep function:



Press the sleep button to enter sleep mode. After entering sleep mode, the sleep indicator and power indicator will be half on, with the rest of the indicators being turned off. To exit the sleep mode, please press sleep button again or you can directly press the fan speed button to exit sleep mode, then the sleep indicator will be turned off.

### Child-lock function:



Press the child lock button for 3 seconds, then all indicators flash 3 times to enter the child lock mode. After entering child lock mode, the child lock indicator will be turned on. Under "Child Lock Mode", nothing will happen when any of the buttons are pressed. To exit the child lock mode, please press the child lock button for another 3 seconds to exit.

### Time setting:

2 4 6 8



In the power-on state, press the Timer button continuously, 2H -> 4H -> 6H -> 8H -> OFF. The indicator lights turn on warm white in turn. After the timer function is enabled, press and hold Timer for 1.5 seconds to exit the timer mode.

### Reset function:

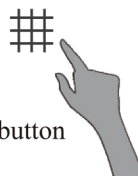

When the filter is replaced and after the user has replaced the filter, press the "Reset" button for 3 seconds, the filter is reset, and the filter replacement indicator is off.

## MaxLite® Air Purifier (AP215SF3B)



### 5: Maintenance and Cleaning

Please unplug power plug before cleaning the product.

Please don't soak this product into water or other liquids, nor immerse it with wet hands.

Please don't use abrasiveness. Use corrosive or flammable detergents (such as bleach or alcohol) to clean any parts of this product.

The composite filter cannot be washed with water.



#### **Clean Air Purifier:**

Regularly clean the inside and outside of the purifier body to prevent dust accumulation.

1. Use soft dry cloth to wipe off the dust on the product body.
2. Clean the air inlet and air outlet with soft dry cloth.



# MaxLite® Air Purifier (AP215SF3B)

## 5: Replacing the Filter (APF-H13BV2)

When the reset button indicator flashes, the user is reminded to replace the filter.



Resetting

**▲ CAUTION**

When the product works, the filter replacement indicator turns on RED to remind the user to replace the filter, but the purifier can still work normally.

**▲ CAUTION**

Please turn off the product and unplug the power plug before replacing the filter. After replacing the filter, if the replacement indicator still flashes after starting up, please press the reset button for 3 seconds to reset the filter. The filter replacement indicator is turned off and the filter reset is completed.

**Note: Please remove the plastic packaging on the filter before putting it into air purifier unit.**

**Operation Steps:**

1. Instrument reminds to replace filter



Resetting

2. Turn off the power supply, stop the purifier, and then unplug the power plug.

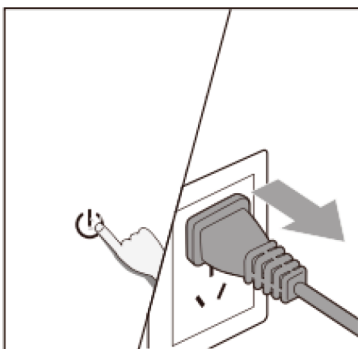

3. Press the bottom cover with your fingers and screw it out in the unlocking direction while taking out the bottom cover upward.

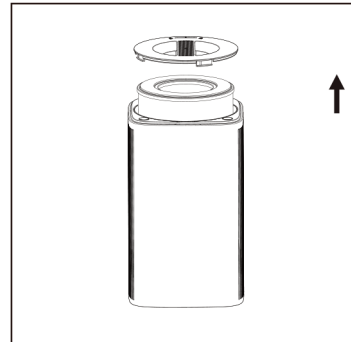

4. Remove the filter inside the purifier and replace the filter.

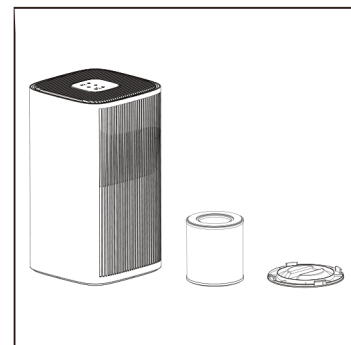

5. Remove the packaging material of the new filter.

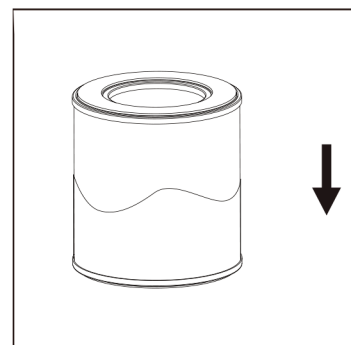

# MaxLite® Air Purifier (AP215SF3B)



## 5: Replacing the Filter (Continued)

6. Put the filter into the purifier

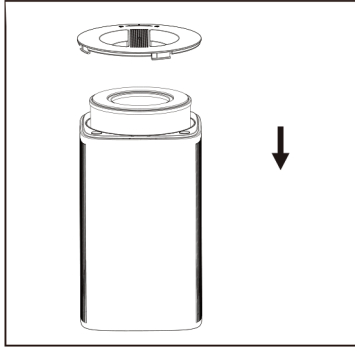

7. Put in the filter again, press the indicator button to put in the bottom cover and tighten it

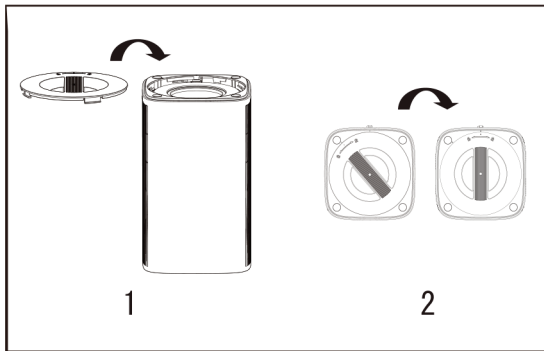

8. After replacing the filter, plug in the power plug and press the reset button for 3 seconds to reset the instrument.

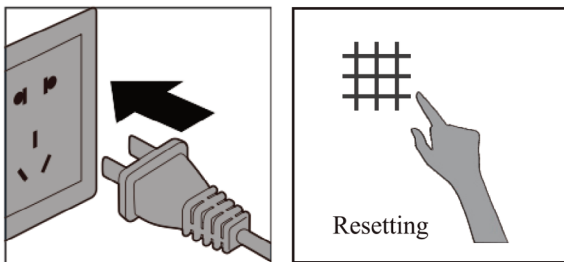

### When it's unused for a long time:

Unplug the power plug. (Because the instrument also consumes power in standby state.) Thoroughly dry the interior.

Store the instrument in a dry and ventilated place for safekeeping. (Storing it flat or upside down may cause equipment failure)

### Reference time for replacement of filter:

The filter of this product is Pre-filter + HEPA + activated carbon filter. The filter cannot be washed with water and is easy to damage. Please don't press hard. Generally, the service period is six months.

The above time is only a reference time, and users can change it in advance according to the actual use environment.

### **CAUTION**

Please turn off the instrument and cut off the power plug before replacing the filter.

MaxLite® Air Purifier (AP215SF3B)



**6: Fault Handling**

This chart lists the common problems when using this product. Please contact the Customer Service Center or the distributor if you cannot solve the problem according to the below information.

State	Possible causes	Possible solutions
The machine can't be started	The power plug is not in place	Pull out the power plug and plug in the power again
	The power plug or wire is damaged	Contact customer service center or dealer
Fan not working	The machine is not on	Plug in the power and turn on the machine again
	The motor is damaged	Contact customer service center or dealer
	Motor loose or foreign particles inside the machine	Contact customer service center or dealer
Poor purification performance or no optimal purification capacity	The filter was not replaced	Replace a new set of filter
	The air inlet or outlet of the machine is blocked	Contact customer service center or dealer
	The plastic package of the filter is not removed	Remove the plastic package of the filter screen for reuse
	There is no proper clearance or space around the machine to ventilate it	Make sure that the air inlet and outlet of the machine are not less than 20cm away from the obstacles
	There is no filter in the machine	Make sure that the filters are placed in the machine in the order indicated
	More than expected room coverage	Recheck whether the area of the used room is consistent with the specified area of the machine

## MaxLite® Air Purifier (AP215SF3B)



### 6: Warranty and Service

If you need information or have any questions, you can contact our Customer Service Center or distributor.

#### **Ordering Parts or Accessories:**

Please contact your Customer Service Center or distributor to select accessories if you need to replace parts or purchase additional parts.

#### **Optional Accessories:**



**Model: APF-H13BV2**  
Pre-filter + HEPA + activated  
carbon composite filter

### 7: Other Information

Please don't dispose with ordinary domestic garbage when disposing the product. Please learn about the local regulations on classified collection of electronic or electrical products.

Proper disposal of old products helps to avoid potential negative impacts on the environment and human health.